

MG3641A/MG3642A
Synthesized Signal Generator
Operation Manual

14th Edition

**For safety and warning information, please read this manual before attempting to use the equipment.
Keep this manual with the equipment.**

ANRITSU CORPORATION

Safety Symbols

To prevent the risk of personal injury or loss related to equipment malfunction, Anritsu Corporation uses the following safety symbols to indicate safety-related information. Ensure that you clearly understand the meanings of the symbols BEFORE using the equipment. Some or all of the following symbols may be used on all Anritsu equipment. In addition, there may be other labels attached to products that are not shown in the diagrams in this manual.

Symbols used in manual

DANGER  This indicates a very dangerous procedure that could result in serious injury or death if not performed properly.

WARNING  This indicates a hazardous procedure that could result in serious injury or death if not performed properly.

CAUTION  This indicates a hazardous procedure or danger that could result in light-to-severe injury, or loss related to equipment malfunction, if proper precautions are not taken.

Safety Symbols Used on Equipment and in Manual

The following safety symbols are used inside or on the equipment near operation locations to provide information about safety items and operation precautions. Ensure that you clearly understand the meanings of the symbols and take the necessary precautions BEFORE using the equipment.



This indicates a prohibited operation. The prohibited operation is indicated symbolically in or near the barred circle.



This indicates an obligatory safety precaution. The obligatory operation is indicated symbolically in or near the circle.



This indicates a warning or caution. The contents are indicated symbolically in or near the triangle.



This indicates a note. The contents are described in the box.



These indicate that the marked part should be recycled.

MG3641A/MG3642A
Synthesized Signal Generator
Operation Manual

10 March 1997 (First Edition)
12 January 2012 (14th Edition)

Copyright © 1997-2012, ANRITSU CORPORATION.

All rights reserved. No part of this manual may be reproduced without the prior written permission of the publisher.

The contents of this manual may be changed without prior notice.

Printed in Japan

For Safety

WARNING



1. ALWAYS refer to the operation manual when working near locations at which the alert mark shown on the left is attached. If the advice in the operation manual is not followed there is a risk of personal injury or reduced equipment performance. The alert mark shown on the left may also be used with other marks and descriptions to indicate other dangers.

2. IEC 61010 Standard

The IEC 61010 standard specifies four categories to ensure that an instrument is used only at locations where it is safe to make measurements. This instrument is designed for measurement category I (CAT I). DO NOT use this instrument at locations specified as category II, III, or IV as defined below.

Measurement category I (CAT I):

Secondary circuits of a device that is not directly connected to a power outlet.

Measurement category II (CAT II):

Primary circuits of a device that is directly connected to a power outlet, e.g., portable tools or home appliance.

Measurement category III (CAT III):

Primary circuits of a device (fixed equipment) to which power is supplied directly from the distribution panel, and circuits running from the distribution panel to power outlet.

Measurement category IV (CAT IV):

Building service-line entrance circuits, and circuits running from the service-line entrance to the meter or primary circuit breaker (distribution panel).

For Safety

WARNING

Electric Shock

3. To ensure that the instrument is earthed, always use the supplied 3-pin power cord, and insert the plug into an outlet with an earth terminal. If power is supplied without earthing the equipment, there is a risk of receiving a severe or fatal electric shock or causing damage to the internal components.

Repair

WARNING 

4. This equipment cannot be repaired by the operator. DO NOT attempt to remove the equipment covers or unit covers or to disassemble internal components. Only qualified service personnel with a knowledge of electrical fire and shock hazards should service this equipment. There are high-voltage parts in this equipment presenting a risk of severe injury or fatal electric shock to untrained personnel. In addition, there is a risk of damage to precision components.

Calibration



5. The performance-guarantee seal verifies the integrity of the equipment. To ensure the continued integrity of the equipment, only Anritsu service personnel, or service personnel of an Anritsu sales representative, should break this seal to repair or calibrate the equipment. If the performance-guarantee seal is broken by you or a third party, the performance of the equipment cannot be guaranteed.

Falling Over

6. This equipment should always be positioned in the correct manner. If the cabinet is turned on its side, etc., it will be unstable and may be damaged if it falls over as a result of receiving a slight mechanical shock.

Always set up the equipment in a position where the power switch can be reached without difficulty.

For Safety

CAUTION

Fuse Replacement

CAUTION 

1. Always remove the mains power cable from the power outlet before replacing blown fuses. There is a risk of electric shock if fuses are replaced with the power cable connected. Always use new fuses of the type and rating specified on the rear panel of the instrument. There is a risk of fire if a fuse of a different rating is used.

T5A indicates a time-lag fuse.

Cleaning

2. Keep the power supply and cooling fan free of dust.
 - Clean the power inlet regularly. If dust accumulates around the power pins, there is a risk of fire.
 - Keep the cooling fan clean so that the ventilation holes are not obstructed. If the ventilation is obstructed, the cabinet may overheat and catch fire.
3. Use two or more people to lift and move this equipment, or use a trolley. There is a risk of back injury, if this equipment is lifted by one person.

 CAUTION/注意

>18kg

HEAVY WEIGHT/重量物

For Safety

CAUTION

Replacing Memory Back-up Battery

This equipment uses a Poly-carbomonofluoride lithium battery to backup the memory. This battery must be replaced by service personnel when it has reached the end of its useful life; contact the Anritsu sales section or your nearest representative.

Note: The battery used in this equipment has a maximum useful life of 7 years. It should be replaced before this period has elapsed.

Use in a residential environment

This instrument is designed for an industrial environment.

In a residential environment this instrument may cause radio interference in which case the user may be required to take adequate measures.

Equipment Certificate

Anritsu Corporation certifies that this equipment was tested before shipment using calibrated measuring instruments with direct traceability to public testing organizations recognized by national research laboratories, including the National Institute of Advanced Industrial Science and Technology, and the National Institute of Information and Communications Technology, and was found to meet the published specifications.

Anritsu Warranty

Anritsu Corporation will repair this equipment free-of-charge if a malfunction occurs within one year after shipment due to a manufacturing fault. However, software fixes will be made in accordance with the separate Software End-User License Agreement. Moreover, Anritsu Corporation will deem this warranty void when:

- The fault is outside the scope of the warranty conditions described in the operation manual.
- The fault is due to mishandling, misuse, or unauthorized modification or repair of the equipment by the customer.
- The fault is due to severe usage clearly exceeding normal usage.
- The fault is due to improper or insufficient maintenance by the customer.
- The fault is due to natural disaster including fire, flooding, earthquake, etc.
- The fault is due to use of non-specified peripheral equipment, peripheral parts, consumables, etc.
- The fault is due to use of a non-specified power supply or in a non-specified installation location.

In addition, this warranty is valid only for the original equipment purchaser. It is not transferable if the equipment is resold.

Anritsu Corporation shall assume no liability for injury or financial loss of the customer due to the use of or a failure to be able to use this equipment.

Anritsu Corporation Contact

In the event that this equipment malfunctions, contact an Anritsu Service and Sales office. Contact information can be found on the last page of the printed version of this manual, and is available in a separate file on the CD version.

Notes On Export Management

This product and its manuals may require an Export License/Approval by the Government of the product's country of origin for re-export from your country.

Before re-exporting the product or manuals, please contact us to confirm whether they are export-controlled items or not.

When you dispose of export-controlled items, the products/manuals need to be broken/shredded so as not to be unlawfully used for military purpose.

Crossed-out Wheeled Bin Symbol

Equipment marked with the Crossed-out Wheeled Bin Symbol complies with council directive 2002/96/EC (the “WEEE Directive”) in European Union.



For Products placed on the EU market after August 13, 2005, please contact your local Anritsu representative at the end of the product's useful life to arrange disposal in accordance with your initial contract and the local law.

CE Conformity Marking

Anritsu affixes the CE conformity marking on the following product(s) in accordance with the Council Directive 93/68/EEC to indicate that they conform to the EMC and LVD directive of the European Union (EU).

CE marking



1. Product Model

Model: MG3641A/MG3642A Synthesised Signal Generator

2. Applied Directive

EMC: Directive 2004/108/EC
LVD: Directive 2006/95/EC

3. Applied Standards

- EMC: Emission: EN 61326-1: 2006 (Class A)
Immunity: EN 61326-1: 2006 (Table 2)

	Performance Criteria*
IEC 61000-4-2 (ESD)	B
IEC 61000-4-3 (EMF)	A
IEC 61000-4-4 (Burst)	B
IEC 61000-4-5 (Surge)	B
IEC 61000-4-6 (CRF)	A
IEC 61000-4-8 (RPFMF)	A
IEC 61000-4-11 (V dip/short)	B, C

*: Performance Criteria

A: During testing, normal performance within the specification limits.

B: During testing, temporary degradation, or loss of function or performance which is self-recovering.

C: During testing, temporary degradation, or loss of function or performance which requires operator intervention or system reset occurs.

Harmonic current emissions:

EN 61000-3-2: 2006 (Class A equipment)

- LVD: EN 61010-1: 2001 (Pollution Degree 2)

4. Authorized representative

Name: Murray Coleman
Head of Customer Service EMEA
ANRITSU EMEA Ltd.
Address, city: 200 Capability Green, Luton
Bedfordshire, LU1 3LU
Country: United Kingdom

C-tick Conformity Marking

Anritsu affixes the C-tick mark on the following product(s) in accordance with the regulation to indicate that they conform to the EMC framework of Australia/New Zealand.

C-tick marking



1. Product Model

Model: MG3641A/MG3642A Synthesised Signal Generator

2. Applied Standards

EMC: Emission: EN 61326-1: 2006 (Class A equipment)

Power Line Fuse Protection

For safety, Anritsu products have either one or two fuses in the AC power lines as requested by the customer when ordering.

Single fuse: A fuse is inserted in one of the AC power lines.

Double fuse: A fuse is inserted in each of the AC power lines.

Example 1: An example of the single fuse is shown below:

Fuse Holder

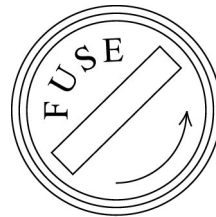

Example 2: An example of the double fuse is shown below:

Fuse Holders

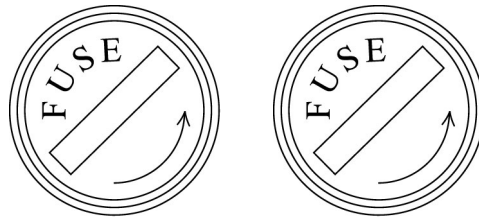

TABLE OF CONTENTS

For Safety	iii
SECTION 1 GENERAL	1-1
1.1 Brief Description	1-1
1.2 Operation Manual	1-2
1.3 Composition of Devices	1-3
1.3.1 Standard Composition	1-3
1.3.2 Options	1-4
1.4 Application Parts	1-5
1.5 Specifications	1-6
SECTION 2 PRECAUTION	2-1
2.1 Installation Precautions	2-1
2.1.1 Installation site environmental conditions	2-1
2.2 Safety Measures	2-2
2.2.1 General power supply safety measures	2-2
2.2.2 Reverse power input to RF output connector	2-2
2.3 Mounting the MG3641A/MG3642A in the Frame	2-3
2.4 Preparation Before Power-On	2-4
2.4.1 Connecting the Power Cord	2-5
2.4.2 Fuse Replacement	2-6
SECTION 3 PANEL LAYOUT	3-1
3.1 Panel Layout	3-1
3.1.1 Front panel layout	3-1
3.1.2 Rear panel layout	3-3
3.1.3 Panel layout diagram	3-4
SECTION 4 OPERATING INSTRUCTIONS	4-1
4.1 Turning Power On/Off	4-1
4.1.1 Turning Power On	4-3
4.1.2 Turning Power Off	4-4
4.2 Explanation of Screens	4-5
4.3 Initial Settings	4-6
4.4 Setting the Frequency	4-8
4.4.1 Setting the Frequency	4-8
4.4.2 Displaying the Frequency Relative Value	4-9
4.4.3 Frequency Offset	4-10
4.5 Setting the Output Level	4-11
4.5.1 Setting the Output Level	4-11
4.5.2 Displaying the Output Level Relative Value	4-12
4.5.3 Output Level Offset	4-13

4.5.4	Level Continuous Mode	4-14
4.5.5	Switching the Output Signal On/Off	4-15
4.5.6	Special Functions Related to Level	4-16
4.6	Setting the Modulation	4-18
4.6.1	Outline of Modulation	4-18
4.6.2	Setting the Modulation Function	4-19
4.6.3	Setting the Modulation Factor and Frequency Deviation	4-20
4.6.4	Setting Range of FM Frequency Deviation	4-21
4.6.5	Polarity of Modulation Signal	4-21
4.6.6	Pulse Modulation	4-22
4.7	Setting the Modulation Signal Source	4-24
4.7.1	Internal Modulation Signal (Int1)	4-24
4.7.2	Internal Modulation Signals (Int2, Int3)	4-25
4.7.3	External Modulation Signals (Ext1, Ext2)	4-26
4.8	Setting the AF Output	4-28
4.9	Memory Functions	4-30
4.9.1	Outline of Memory Functions	4-30
4.9.2	Storing in the Memory	4-30
4.9.3	Recalling Memory Contents	4-31
4.9.4	Clearing the Memory	4-33
4.9.5	Selecting the Memory Recall Mode	4-34
4.10	Sweep Functions	4-35
4.10.1	Outline of Sweep Functions	4-35
4.10.2	Setting and Executing the Sweep	4-36
4.10.3	Sweep Auxiliary Outputs	4-39
4.11	Trigger Functions	4-41
4.11.1	Outline of trigger function	4-41
4.11.2	Registering the trigger program	4-42
4.11.3	Executing the trigger program	4-43
4.11.4	Checking the contents of the trigger program	4-44
4.12	Miscellaneous Functions	4-45
4.12.1	Setting Display On/Off	4-45
4.12.2	Setting Bell • Alarm On/Off	4-46
4.12.3	Setting address and only mode of GPIB	4-47
4.12.4	Panel Lock	4-48
4.13	Removing Reverse Power Protection (RPP) Circuit Operation	4-49
4.14	Error Messages	4-50

SECTION 5 MEASUREMENT 5-1

5.1	Measurement of Sensitivity	5-1
5.1.1	Measuring 20 dB NQ sensitivity	5-2
5.1.2	Measuring 12 dB SINAD sensitivity	5-3

5.2	Measuring the 1-signal Selectivity	5-4
5.2.1	Measuring selectivity characteristics of the FM receiver in 20 dB NQ method	5-4
5.2.2	Measuring spurious response	5-7
5.3	Measuring the 2-signal Sensitivity	5-9
5.3.1	Measuring the sensitivity blocking of the FM receiver	5-9
5.3.2	Measuring the cross-modulation characteristics	5-12
SECTION 6 GPIB		6-1
6.1	Outline of GPIB	6-1
6.1.1	Overview	6-1
6.1.2	GPIB functions	6-1
6.1.3	Setup example	6-2
6.1.4	Standard	6-3
6.2	Device Message List	6-4
6.2.1	Outline	6-4
6.2.2	General Information On SCPI	6-4
6.2.3	Command Structure	6-4
6.2.4	Writing Commands	6-5
6.2.5	Compounding Commands	6-6
6.2.6	Parameter	6-7
6.2.7	Unit	6-7
6.2.8	Command Tree	6-8
6.3	Connecting the GPIB Cable	6-14
6.4	Device Message Format	6-15
6.4.1	Program message format	6-15
6.4.2	Response message format	6-18
6.5	Status Message	6-20
6.5.1	Status register configuration	6-20
6.5.2	IEEE488.2-based status register	6-21
6.5.3	SCPI standard status register	6-22
6.5.4	Reading, writing, clearing, and resetting the status register	6-23
6.5.5	SCPI error messages	6-25
6.6	Initializing Device	6-27
6.6.1	Bus initialization	6-27
6.6.2	Message initialization	6-27
6.6.3	Device initialization	6-27
6.6.4	Device state at power-on	6-27
6.7	Detailed Description of Commands	6-28
6.7.1	Frequency subsystem	6-28
6.7.2	Output level subsystem	6-32
6.7.3	AM subsystem	6-38
6.7.4	FM subsystem	6-39
6.7.5	PM subsystem	6-41

6.7.6	Modulation source subsystem	6-42
6.7.7	MEMORY subsystem	6-45
6.7.8	Display subsystem	6-47
6.7.9	System subsystem	6-48
6.7.10	Status subsystem	6-49
6.8	IEEE488.2 Common Command	6-51
6.9	Sample Program	6-53
6.10	GPIB Command Interchange Function	6-56
6.10.1	Outline	6-56
6.10.2	Restrictions in MG3633A command interchange mode	6-57
6.10.3	Restrictions in MG3631A/32A command interchange mode	6-60
SECTION 7	PERFORMANCE TEST	7-1
7.1	Performance Test Required	7-1
7.2	Performance Test Device List	7-2
7.3	Performance Test	7-3
7.3.1	Output frequency	7-4
7.3.2	Output level frequency characteristics	7-5
7.3.3	Output level accuracy	7-6
7.3.4	FM deviation and FM distortion	7-8
7.3.5	AM modulation factor and AM distortion	7-10
SECTION 8	CALIBRATION	8-1
8.1	Calibration Required	8-1
8.2	Calibration Device List	8-1
8.3	Calibration	8-2
SECTION 9	STORAGE AND TRANSPORTATION	9-1
9.1	Daily Servicing and Preventive Maintenance	9-1
9.2	Storage Precautions	9-1
9.2.1	Precautions before storage	9-1
9.2.2	Recommended storage conditions	9-2
9.3	Repacking and Transportation	9-2
9.3.1	Repacking	9-2
9.3.2	Transportation	9-2
APPENDIX A	INITIAL FACTORY SETTINGS	A-1
APPENDIX B	FUNCTION-KEY TRANSITION	B-1
APPENDIX C	FRONT AND REAR PANEL LAYOUT	C-1
APPENDIX D	INDEX	D-1
APPENDIX E	PERFORMANCE TEST RESULT SHEET	E-1

SECTION 1

GENERAL

1.1 Brief Description

The MG3641A/MG3642A is a synthesized signal generator capable of outputting highly accurate, highly pure signals over a broad frequency range.

The extremely excellent spurious characteristics and leakage characteristics offer to make the signal generator most suitable to evaluate sensitivity characteristics and interference characteristics, which comprise the basic performance of radio equipment.

Meanwhile, the signal generator can also be used to test communication systems operating with a variety of modulation methods, such as a pager system, since it provides diverse modulation functions and frequency modulation with good carrier frequency stability.

Its output level can be corrected over the entire frequency range. Because the signal generator allows to select high level outputs and high resolutions, it can also serve to test various high frequency components.

The generator displays its basic functions, such as frequency, output level, and memory addresses, on a 7-segment display unit. For those functions which require to have many parameters set, such as modulation, sweep function, etc., it adopts the multimenu display. Moreover, the generator boasts of an outstanding operability, since it comes equipped with a dedicated rotary knob and step keys for setting output levels.

SECTION 1 GENERAL

1.2 Operation Manual

This operation manual contains 9 sections and 5 appendixes. The format and outline of each section is described below.

Table 1-1

Section	Title	Contents
1	GENERAL	Description of the MG3641A/MG3642A (standard configuration, specifications), optional accessories and peripheral equipment, and outline of operation manual.
2	PRECAUTION	Operations to be performed before powering-up the MG3641A/MG3642A
3	PANEL LAYOUT	Layout, function and method of preparative operation of components such as keys, connectors, knobs, and indicators on both the front and rear panels.
4	OPERATING INSTRUCTIONS	Details of manual operation (local operation) of the front and rear panels. (Except for remote control by GPIB)
5	MEASUREMENT	Explains how to measure the sensitivity and selectivity, giving typical examples using the signal generator
6	GPIB	Remote-control operational procedure and description of device messages
7	PERFORMANCE TEST	Description of the measuring unit and performance test required to test the performance of this device
8	CALIBRATION	Description of the calibration as the preventive maintenance to prevent the performance from reducing.
9	STORAGE AND TRANSPORTATION	Daily maintenance, long period storage, re-packing and transportation
APPENDIX	A INITIALSETTINGS	
	B FUNCTION KEY TRANSITION DIAGRAM	
	C FRONT AND REAR PANEL LAYOUT	
	D INDEX	
	E PERFORMANCE TEST RESULT SHEET	

1.3 Composition of Devices

The composition of standard accessories to the MG3641A/MG3642A will be explained in this section.

1.3.1 Standard Composition

The table below shows the standard composition of devices for the MG3641A/MG3642A.

Table 1-2. Standard Composition of Devices

Item	Model/Symbol	Product Name	Q'ty	Remarks
Main unit	MG3641A/ MG3642A	Synthesized signal generator	1	
Accessories		Power cord	1	Length: approx. 2.6 m
	B0325	GPIB shield cap	1	
	F0013 or F0012	Fuse	1	Two of 5 A (T5 A 250 V) for 100 VAC system or Two of 3.15 A (T3.15 A 250 V), for 200 VAC system
	W1137AE	Operation manual	1	English version

1.3.2 Options

The table below lists options for the MG3641A/MG3642A.

Table 1-3. Options

Option No.	Model number/ Order number	Name	
01	MG3641A/ MG3642A-01	Reference Crystal Oscillator	Frequency: 10 MHz Aging rate: 5×10^{-10} /day Temperature characteristics: $\pm 5 \times 10^{-9}$ (at 0 to 50°C)
11	MG3641A/ MG3642A-11	Pulse modulator	ON/OFF ratio: >80 dB Rise time/fall time: <100 ns Minimum pulse width: <500 ns Pulse repetition frequency: DC to 1 MHz Maximum delay time: <100 ns Overshoot/ringing: <20 % Video feed through: <20 % Pulse modulation signal: External, BNC connector on the rear panel, 50 Ω /600 Ω , TTL(Positive logic)
21	MG3641A/ MG3642A-21	AF synthesizer	Frequency : 0.01 Hz to 400 kHz (sine wave) : 0.01 Hz to 50 kHz (triangular, square, sawtooth wave) Resolution : 0.01 Hz Wave form: sine wave, triangular wave, square wave, sawtooth wave Frequency accuracy: Equal to the accuracy of the reference oscillator.
22	MG3641A/ MG3642A-22	FSK encoder	2-level FSK, 4-level FSK
23	MG3641A/ MG3642A-23	Pattern generator	

1.4 Application Parts

The table below lists application parts for the MG3641A/MG3642A, which are all optional purchase items.

Table 1-4. Application Parts

Model/Symbol	Product Name	Remarks
J0576B	Coaxial cord	N-P·5D-2W·N-P, 1 m
J0127A	Coaxial cord	BNC-P·RG58A/U·BNC-P, 1 m
J0007	GPIB cable	408JE-101, 1 m
J0008	GPIB cable	408JE-102, 2 m
MA1612A	Four-port junction pad	5 to 3000 MHz, 50 Ω
MP721□	Fixed attenuator	DC to 12.4 GHz, 3, 6, 10, 20, 30, 40, 50, 60 dB
B0395C	Rack mount kit	EIA/IEC
B0329G	Front cover	
B0330F	Tilt stand	
B0412A	Carring case	

1.5 Specifications

Carrier Frequency	Range	125 kHz to 1040 MHz: MG3641A 125 kHz to 2080 MHz: MG3642A	
	Resolution	0.01 Hz	
	Accuracy	Dependent on the accuracy of the reference oscillator. In the FM modulation, Accuracy of reference frequency $\pm(0.3\%$ of FM deviation setting +5 Hz)	
	Internal reference oscillator *1	Frequency	10 MHz
		Aging rate	$\pm 5 \times 10^{-9}$ /day
		Startup characteristics	1×10^{-7} /10 min. (reference after 24-hour operation)
		Temperature stability	$\pm 3 \times 10^{-8}$ (0 to 50°C)
	External reference input	5/10 MHz, ± 10 ppm, ≥ 0.7 Vp-p/50 Ω (AC coupling) BNC connector on the rear panel	
Buffer output	10 MHz, TTL level (DC coupling) BNC connector on the rear panel		
Switching time	Response time from last command, till the preset frequency ± 0.1 ppm is obtained, under external control: <40 ms		
Output level	Range	-143 to +17 dBm (Permissible setting range: -143 to +23 dBm)	
	Unit	dBm, dB μ , V, mV, μ V (Switching between terminated-voltage display and open-voltage display is possible for dB μ , V, mV and μ V)	
	Resolution	0.01dB	
	Frequency response	With reference to 0 dBm ± 0.5 dB ± 1.0 dB (With pulse modulation on)*2	
	Accuracy	With pulse modulation off ± 1 dB ($\leq +17$ dBm, ≥ -127 dBm) ± 3 dB (< -127 dBm) With pulse modulation on*2 ± 1 dB ($\leq +12$ dBm, ≥ -127 dBm) ± 3 dB (< -127 dBm)	
	Impedance	50 Ω , type N connector VSWR: < 1.5 (≤ -3 dBm) < 2.5 (> -3 dBm)	
	Switching time	Response time from last command, till the final level ± 0.5 dB is obtained, under external control: <50 ms (Normal mode) <100 ms (Level safety mode) <10 ms (continuous mode)	
	Special setting mode	Level continuous mode: Level can be varied over a range of the set value ± 10 dB, without interruptions of the output Level safety mode: Level is narrowed to prevent spike-like signals from appearing when the mechanical attenuator is working.	

*1 Available up to 5×10^{-10} /day with Reference Crystal Oscillator(Opt.01)

*2 Only with Pulse Modulator(Opt. 11) installed

Specifications (continued)

Output level	Interference radiation distortion	When measured with 50 Ω -terminated voltage using a two-loop antenna of 25 mm in diameter at 25 mm away from the case: <0.1 μ V (At the output frequency) <1 μ V (Over the frequency range, at multitemenu display OFF)		
Signal Purity	Spurious	In CW mode and with reference to $\leq +7$ dBm: Harmonics: <-30 dBc Non-harmonics: <-100 dBc (≥ 15 kHz offset) Those related to power: <-40 dBc (<15 kHz offset)		
	SSB phase noise	In CW mode and with reference to 20 kHz offset: <-140 dBc/Hz (≥ 10 MHz, <256 MHz) <-136 dBc/Hz (≥ 256 MHz, <512 MHz) <-130 dBc/Hz (≥ 512 MHz, ≤ 1040 MHz) <-124 dBc/Hz (>1040 MHz, MG3642A)		
	Residual AM	With reference to ≥ 500 kHz, CW mode, +7 dBm and in a 50 Hz to 15 kHz demodulation band: <-80 dBc		
	Residual FM	In CW mode and in a 300 Hz to 3 kHz demodulation band: <4 Hzrms (≥ 10 MHz, <512 MHz) <8 Hzrms (≥ 512 MHz, ≤ 1040 MHz) <16 Hzrms (>1040 MHz, MG3642A) In CW mode and in a 50 Hz to 15 kHz demodulation band: <5 Hzrms (≥ 10 MHz, <512 MHz) <10 Hzrms (≥ 512 MHz, ≤ 1040 MHz) <20 Hzrms (>1040 MHz, MG3642A)		
Amplitude modulation	Range	0 to 100 %		
	Resolution	0.1 %		
	Accuracy	With reference to ≥ 0.4 MHz, $\leq +7$ dBm, AM ≤ 90 %, Source=Int1 1 kHz, and in a 300 Hz to 3 kHz demodulation band: $\pm(5$ % of set value +2 %)		
	Modulation frequency response	In $\leq +7$ dBm and ± 1 dB Bandwidth:		
		Carrier frequency	Lower limit frequency	Upper limit frequency
			AM = 30 %	AM = 90 %
≥ 0.4 MHz, <0.5 MHz		DC (Ext DC couple) 20 Hz (Ext AC couple)	2 kHz	1 kHz
≥ 0.5 MHz, <2 MHz			10 kHz	5 kHz
≥ 2 MHz, <32 MHz			20 kHz	
≥ 32 MHz, <64 MHz	50 kHz			
≥ 64 MHz	50 kHz			
	100 kHz (3 dB Bandwidth)			
Distortion	With reference to ≥ 0.4 MHz, $\leq +7$ dBm, Source = Int1 1 kHz: <-40 dB (AM = 30 %) <-30 dB (AM = 90 %)			

Specifications (continued)

Amplitude modulation	Incidental FM	With reference to ≥ 0.4 MHz, $\leq +7$ dBm, $AM \leq 30\%$, Source=Int1 1 kHz, and in a 300 Hz to 3 kHz demodulation band: <200 Hzpeak
	Modulation signal source	Any one out of the internal modulation signal sources (Int1, Int2, Int3) and external modulation inputs (Ext1, Ext2) can be selected.
	Modulation signal polarity	Can be switched between positive and negative.
Frequency modulation	Range	0 to 125 Hz (≥ 125 kHz, <250 kHz) 0 to 250 Hz (≥ 250 kHz, <500 kHz) 0 to 500 Hz (≥ 500 kHz, <1 MHz) 0 to 1 kHz (≥ 1 MHz, <2 MHz) 0 to 2 kHz (≥ 2 MHz, <4 MHz) 0 to 4 kHz (≥ 4 MHz, <8 MHz) 0 to 10 kHz (≥ 8 MHz, <16 MHz) 0 to 25.6 kHz (≥ 16 MHz, <32 MHz) 0 to 51.2 kHz (≥ 32 MHz, <64 MHz) 0 to 102 kHz (≥ 64 MHz, <128 MHz) 0 to 256 kHz (≥ 128 MHz, <256 MHz) 0 to 512 kHz (≥ 256 MHz, <512 MHz) 0 to 1024 kHz (≥ 512 MHz, ≤ 1040 MHz) 0 to 2048 kHz (> 1040 MHz, MG3642A)
	Resolution	1 Hz (0 to 4.000 kHz deviation) 10 Hz (4.010 to 10.000 kHz deviation) 25 Hz (10.025 to 25.600 kHz deviation) 50 Hz (25.65 to 51.20 kHz deviation) 100 Hz (51.30 to 102.00 kHz deviation) 250 Hz (102.25 to 256.00 kHz deviation) 500 Hz (256.5 to 512.0 kHz deviation) 1 kHz (513 to 1024 kHz deviation) 1 kHz (1025 to 2048 kHz deviation, MG3642A)
	Accuracy	With reference to ≥ 0.4 MHz, Source=Int1 1 kHz, and in a 300 Hz to 3 kHz demodulation band: $\pm(5\%$ of set value +10 Hz) (≥ 0.4 MHz, <512 MHz) $\pm(5\%$ of set value +20 Hz) (≥ 512 MHz, ≤ 1040 MHz) $\pm(5\%$ of set value +40 Hz) (> 1040 MHz, MG3642A)
	Modulation frequency response	In a ± 1 dB bandwidth DC (Ext DC couple) or 20 Hz (Ext AC couple) to 20 kHz (≥ 0.4 MHz, <10 MHz) DC (Ext DC couple) or 20 Hz (Ext AC couple) to 100 kHz (≥ 10 MHz)
	Distortion	With reference to ≥ 16 MHz: -40 dB (FM=3.5 kHz deviation, and Source=Int1 1 kHz), -45 dB (FM=22.5 kHz deviation, and Source=Int1 1 kHz)
	Incidental AM	With reference to ≥ 64 MHz, $\leq +7$ dBm, FM 100 kHz deviation, Source=Int1 1 kHz, and in a 300 Hz to 3 kHz demodulation band: <1 %peak
	External modulation group delay	With reference to ≥ 10 MHz, Source=Ext DC coupling, and modulation rate ≤ 100 kHz: <30 μ s
	Modulation signal source	Any one out of the internal modulation signal sources (Int1, Int2, Int3) and external modulation inputs (Ext1, Ext2) can be selected for each of FM1 and FM2.
	Modulation signal polarity	Can be switched between positive and negative independently for FM1 and FM2.

Specifications (continued)

Pulse modulation	See specifications of options.	
Modulation signal source	Internal modulation (Int1)	Frequency: 400 Hz/1 kHz (Switched over) Frequency accuracy: Equal to the accuracy of the reference oscillator.
	Internal modulation (Int2, Int3)	See specifications of options.
	External modulation (Ext1, Ext2)	Optimum input level: Approx. 2 V _{p-p} Input impedance: 600 Ω, BNC connector on the front panel Coupling: Switchable between AC/DC
AF Output	Output signal source	Any one out of the internal modulation signal sources (Int1, Int2, Int3) and external modulation inputs (Ext1, Ext2) can be selected.
	Output level	0 to 4 V _{p-p}
	Output level resolution	1 mV _{p-p}
	Output level accuracy	In Source=Int1 1 kHz: ±(5% of set value + 2 mV _{p-p})
	Impedance	600 Ω, BNC connector on the front panel
Simultaneous modulation		Simultaneous modulation, AM depth and FM deviation can be set independently for all combinations, except for a combination of AM and pulse modulation.
Sweep function	Sweep parameter	Frequency, Output level, and Memory
	Sweep pattern	Frequency sweep (Start/Stop): Liner (Stepsize specified, number of points specified) Log (1 % specified) Frequency sweep (Center/Span): Liner (Stepsize specified, number of points specified) Level sweep (Start/Stop): dB (Stepsize specified, number of points specified) Sweep in continuous mode (max. 20 dB width) Level sweep (Center/Span): dB (Stepsize specified, number of points specified) Sweep in continuous mode (max. 20 dB width) Memory sweep (Start/Stop)
	Sweep mode	Auto, Single, Manual
	Sweep time	Setting range 1 ms to 600 s/point, Resolution 10 μs/point (Actual sweep time depends on the sweep parameter switching times, frequency, and output level.)
	Auxiliary outputs	X-Output : BNC connector on the rear panel Staircase sawtooth wave worm Start point of sweep: 0 V Stop point of sweep: +10 V Z-Output : BNC connector on the rear panel TTL level When sweeping: H-level Blanking-Output : BNC connector on the rear panel TTL level When switched: L-level Marker-Output : BNC connector on the rear panel TTL level When marker matches: H-level

Specifications (continued)

Other functions	Relative value display	Carrier frequency and output level
	Offset display	Carrier frequency and output level
	Memory	1000 panel setting conditions can be stored and recalled. Recall mode: All panel settings, Frequency only, Frequency and Level.
	Trigger function	An external trigger signal (input from the BNC connector on the rear panel, TTL level) can be used to execute a pre-programmed operation sequence (except for operation of the power switch, Preset key, Local key, and rotary knob). Max. number of sequence steps of trigger program: 20 steps
	Backup	When switched on, the generator restores the same setting conditions that existed immediately before it was last powered off. However, the following are not restored: <ul style="list-style-type: none"> • Data which was in the middle of entry • Remote status • Data which was in the middle of GPIB transfer • Operating status of RPP
	GPIB	Can control all functions, except for pre-programmed operations controlled by the trigger function, and operation of the power switch, Local key, rotary knob, and knob resolution set keys. Interface: SH1, AH1, T5, L3, TE0, SR1, RL1, PP0, DC1, DT1, C0, E2
Reverse power protection	Maximum reverse input power	50 W (≤ 1040 MHz), 25 W (1040 to 2080 MHz, MG3642A only) ± 50 Vac
General	Power	Voltage: *Vac (Up to max. 250 V) Frequency: 47.5 to 63 Hz, 380 to 420 Hz Capacity: 200 VAmx
	Environmental performance	Working temperature range: 0 to 50°C Storage temperature range: -30 to 71°C Conducted disturbance: EN 61326-1: 2006 (Class A) Radiated disturbance: EN 61326-1: 2006 (Class A) Harmonic Current Emission: EN 61000-3-2: 2006 (Class A) Electrostatic Discharge: EN 61326-1: 2006 (Table 2) Electromagnetic Field Immunity: EN 61326-1: 2006 (Table 2) Fast Transient / Burst: EN 61326-1: 2006 (Table 2) Surge: EN 61326-1: 2006 (Table 2) Conducted RF: EN 61326-1: 2006 (Table 2) Power Frequency Magnetic Field: EN 61326-1: 2006 (Table 2) Voltage Dips / Short Interruptions: EN 61326-1: 2006 (Table 2)
	Dimensions and mass	177 H×320 W×451 Dmm, ≤ 20 kg

* Please specify a nominal voltage in the range from 100 and 240 V when ordering the product.

<Option>

■ Option 01 (Reference crystal oscillator)

- Frequency 10MHz
- Aging rate $5 \times 10^{-10}/\text{day}$
- Temperature characteristics $\pm 5 \times 10^{-9}$ (0 to 50°C)

■ Option 11 (Pulse modulator)

- Frequency 0.125 to 2080MHz
- On/Off ratio >80dB
- Rise/Fall time <100ns
- Min. pulse width <500ns
- Pulse repetition frequency DC to 1MHz
- Max. delay time <100ns
- Overshoot/ringing <20%
- Video feed through <20%
- Pulse modulation signal External, rear-panel BNC connector, 50/600 Ω , TTL (positive logic)

■ Option 21 (AF synthesizer)

- Frequency 0.01Hz to 400kHz (sine wave)
0.01Hz to 50kHz (triangular wave, square wave, sawtooth wave)
- Resolution 0.01Hz
- Waveform Sine, triangular, square, sawtooth
- Frequency accuracy Same as reference oscillator

■ Option 22 (FSK encoder)

- Frequency shift amount: Shifts frequency depending on data state, as below.
 - (Data2¹, Data2⁰)=(0, 0): -FM deviation set value
 - (Data2¹, Data2⁰)=(0, 1): -FM deviation set value/3
 - (Data2¹, Data2⁰)=(1, 0): +FM deviation set value
 - (Data2¹, Data2⁰)=(1, 1): +FM deviation set value/3
- Setting frequency: Set frequency for data input in the following timing.
 - Free: Shift frequency at data input.
 - Rise Trig: Shift frequency at rising edge of external clock.
 - Fall Trig: Shift frequency at falling edge of external clock.
- Baseband filter: Following filters can be used to pass signal.
 - Filter type: 10th-order Bessel filter
 - Cutoff frequency: 100Hz to 30kHz(-3dB)
 - Set resolution: Upper 2 digits
- FM deviation accuracy: Same as that of MG3641A/MG3642A, with restriction of no baseband filter (by-passed)
- External modulation signal input
 - Data2⁰: Rear-panel BNC connector (Int Mod Cont 2)
TTL level, pull-down
 - Data2¹: Rear-panel BNC connector (Int Mod Cont 1)
TTL level, pull-down
- External clock signal input
 - Ext Clock: Rear-panel BNC connector (Int Mod Cont 3)
TTL level, pull-up

SECTION 1 GENERAL

(Blank)

SECTION 2

PRECAUTION

This section describes the preparatory work which must be performed before using the MG3641A/MG3642A Synthesized Signal Generator and the precautions relating to (1) installation and (2) power supply. For GPIB cable connection, address setting, etc, see Section 6.

2.1 Installation Precautions

This paragraph describes the MG3641A/MG3642A Synthesized Signal Generator installation precautions and mechanical assembly procedure for mounting the MG3641A/MG3642A in a rack.

2.1.1 Installation site environmental conditions

(1) Location to avoid

The MG3641A/MG3642A operates normally at ambient temperatures of 0° to 50°C.

However, for best performance, do not use or store it in locations where:

- It may be subjected to strong vibrations
- It may be exposed to extreme humidity or dust
- It may be exposed to direct sunlight
- It may be exposed to explosive gases

To maintain stable measurement for a long time, in addition to meeting the conditions listed above, the MG3641A/MG3642A should be used at stable room temperatures and where the AC line voltage fluctuations are small.

CAUTION: *If the MG3641A/MG3642A is used at room temperature after being used or stored at a low temperature for a long time, condensation may occur inside the instrument which could cause short circuiting. Always ensure that the MG3641A/MG3642A is thoroughly dry before turning on the power.*

(2) Fan clearance

To prevent excessive temperature increase inside the MG3641A/MG3642A, a cooling fan is mounted on the rear panel. Leave a space of at least 10 cm between the rear panel and walls, peripheral devices, obstructions, etc. so that air flow is not obstructed. Do not use the MG3641A/MG3642A on its side.

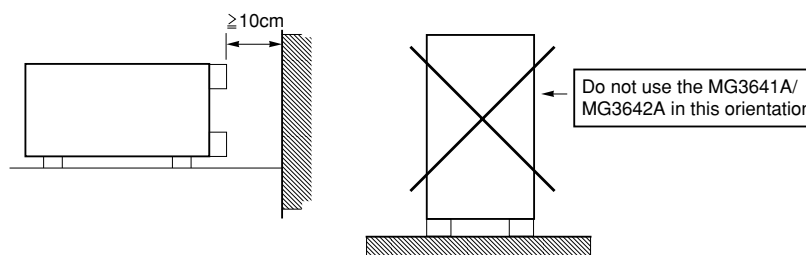

Fig. 2-1. Clearance for Fan

SECTION 2 PRECAUTION

To protect circuits from an abnormal rise in the internal temperature, the MG3641A/MG3642A has a built-in thermal protector. When the thermal protector operates, the MG3641A/MG3642A enters stand-by status (the stby lamp lights).

If the thermal protector starts operating, check conditions surrounding the device and, after lowering the temperature sufficiently, reset switch ○ | on the rear panel. If the thermal protector enters operation repeatedly, the fan may be broken. In this case, have it repaired.

2.2 Safety Measures

This section explains the safety measures required in any case to prevent the operator from being endangered and avoid device damage and serious system-down.

2.2.1 General power supply safety measures

CAUTION ⚠

Before power-on : Be sure to ground the MG3641A/MG3642A. If the power is turned on without the protective grounding, it may result in an electric shock causing death or injury. Also be sure to check the AC line voltage. Applying an abnormal power exceeding the determined value to the device may damage the device and cause fire.

During power supply : To maintain the MG3641A/MG3642A, the operator may have to check and adjust the internal units while opening its cover during power supply. The internal units contain some high-voltage dangerous parts. If the operator touches them carelessly, it may result in an electric shock that affects a person's life and injury. For maintenance of this device, contact qualified service personnel.

2.2.2 Reverse power input to RF output connector

The MG3641A/MG3642A has a reverse power protector in the output unit to protect the internal circuits from a reverse input overpower. The reverse power protector can protect the following power:

- ± 50 Vdc
- 50 W (U_p to 1040 MHz)
- 25 W (1040 to 2080 MHz, MG3642A)

CAUTION ⚠

The reverse power protector uses a mechanical switch. If a reverse power is applied frequently, the contact is consumed. To use this protector, take maximum care not to apply a reverse power. Also never release the reverse power protector as a reverse power remains applied, or a fault will occur in the reverse power protector. The impedance of the RF output connector is opened during operation of the reverse power circuit. Be careful to avoid damage due to a mismatched transmitter, etc.

2.3 Mounting the MG3641A/MG3642A in the Frame

An optional rack mount kit is required to mount the MG3641A/MG3642A in the frame. For the mounting method, refer to the illustration appended to the rack mount kit.

2.4 Preparation Before Power-On

The MG3641A/MG3642A normally operates by connecting the power having the voltage range +10 % to -15 % for the specified nominal voltage 100 to 240 Vac. However, the safety measures are required to avoid the following before the AC power is supplied:

- Accident resulting in injury or death caused by electric shock
- Internal unit damage by abnormal voltage
- Trouble by earth current

To protect the user's safety and call a user's attention, WARNING and CAUTION are indicated on the rear panel as follows:

WARNING

NO OPERATOR SERVICE-
ABLE PARTS INSIDE.
REFER SERVICING TO
QUALIFIED PERSONNEL.

Warning

This measuring instrument that is a precision electronic device has some dangerous parts. The user cannot repair this device, so do not disassemble this device. For services of this device, contact your qualified service personnel.

CAUTION

FOR CONTINUED FIRE
PROTECTION. REPLACE
ONLY WITH SPECIFIED
TYPE AND RATED FUSE.

Caution

Use a specified type and rated contents when replacing a fuse. Using an illegal fuse may result in a fire.

The user must therefore take the safety measures described in the following pages.

2.4.1 Connecting the Power Cord

Check that the "O I" switch on the rear panel is turned off (switched to the (O) side).

Insert the power plug into an outlet, and connect the other end to the power inlet on the rear panel. To ensure that the instrument is grounded, always use the supplied 3-pin power cord, and insert the plug into an outlet with a ground terminal.

WARNING

If the power cord is connected without the instrument grounded, there is a risk of receiving a fatal electric shock. In addition, the peripheral devices connected to the instrument may be damaged.

When connecting to the power supply, DO NOT connect to an outlet without a ground terminal. Also, avoid using electrical equipment such as an extension cord or a transformer.

CAUTION

If an emergency arises causing the instrument to fail or malfunction, disconnect the instrument from the power supply by either turning off the "O I" switch on the rear panel (switch to the (O) side), or by pulling out the power cord or the power inlet.

When installing the instrument, place the instrument so that an operator may easily operate the "O I" switch. If the instrument is mounted in a rack, a power switch for the rack or a circuit breaker may be used for power disconnection.

It should be noted that, the "Stby/On" switch on the front panel of the instrument is a standby switch, and cannot be used to cut the main power.

2.4.2 Fuse Replacement

The MG3641A/MG3642A is supplied with two 5 A or 3.15 A fuses shown in Table 1-2. The fuses are to be loaded inside the fuse holders shown in Figure 2-2.

If a fuse blows, locate the fault and correct the cause before replacing.

CAUTION

If a fuse is replaced with the power turned on, there may be an electric shock hazard. Before replacing a fuse, turn off the POWER switch and unplug the power cord from the AC outlet.

If the power is turned on without the protective grounding, there may be an electric shock hazard. When the AC power voltage is unsuitable, the internal equipment may be damaged by an abnormal power.

Before turning on the power again after replacing a fuse, perform either protective grounding measures described in Section 2.4.1 and check that the AC line voltage is suitable.

CAUTION

If there are no spare fuses, check that the replacement you obtain is of the same type, rated voltage and current as the original.

If the fuse is not of the same type, it may not fit the holder, contact may be poor, or the fusing time may be too long.

If the rated voltage and current of the replacement fuse are too high and trouble recurs, the new fuse may not blow and the instrument could catch fire.

Take these safety measures before replacing a fuse in the following procedure:

STEP	PROCEDURE
1.	Set the POWER switch to OFF and unplug the power cord from the AC outlet.
2.	Turn the fuse-holder cap (see Figure 2-2) counterclockwise and remove the cap together with the fuse.
3.	Remove the blown fuse from the fuse cap and replace it with a spare fuse. (Direction arbitrary)
4.	Refit the cap and clockwise turn it with a standard screwdriver until it will turn no further.

SECTION 3

PANEL LAYOUT

3.1 Panel Layout

This section explains the keys, switches, display, and connectors on the front and rear panels of the MG3641A/MG3642A synthesized signal generator.

3.1.1 Front panel layout

This paragraph outlines the switches and connectors arranged on the front panel.

No	Name, display	Description
1	[F1], [F2], [F3], [F4], and [F5] keys	Used to select and execute the functions corresponding to the key menus displayed on the multi-menu display.
2	Multi-menu display	Displays the operation and state of the modulation, sweep, etc.
3	[More] key	Displays the next page of the multi-menu on the same layer when the current menu has multiple pages
4	Uncal lamp	Lights for the incorrect setting or abnormal operation. Error contents are displayed in the error message area of the multi-menu display.
5	CW and Mod lamp	Displays the current modulation state. The CW lamp lights on without modulation; the Mod lamp lights on with modulation.
6	Memory display	Displays the memory address in the memory mode.
7	Frequency display	Displays the carrier frequency.
8	Output level display	Displays the output level.
9	F-Ofs and L-Ofs lamps	The F-Ofs lamp lights on when the frequency is in offset mode. The L-Ofs lamp lights on when the output level is in offset mode.
10	EMF lamp	The EMF lamp lights on together with the unit lamp when the output level display indicates the open voltage.
11	Cont lamp	Lights on in the output-level continuous mode.
12	[Rel Freq] and [Rel Level] keys	Display the frequency or level in the relative value, respectively. Pressing either key switches to the respective relative display assuming the current frequency or output level as reference value 0. The key lamp then lights on. When either key is pressed in the relative display mode, its lamp goes off and the display returns to the ordinary frequency or output level value. If either key is pressed following the Shift key in the relative or offset display mode, the currently output true frequency or output level is displayed, respectively.
13	Output Level Step [^] and [v] key	Steps up or down the output level. Pressing the v key following the Shift key switches to the output level continuous mode. Pressing the ^ key following the Shift key releases the continuous mode.

SECTION 3 PANEL LAYOUT

No	Name, display	Description
14	Output Level Rotary Knob, Resolution [<] and [>] keys	Specifies the rotary knob for varying the output level and its resolution. When the > key is pressed following the Shift key, the resolution of the rotary knob matches the step size of the step key, and the knob can be set up and down with an arbitrary level step size.
15	RF Output connector	Outputs the MG3641A/MG3642A output signal with impedance 50 Ω .
16	[RF Off/On] key	Turns on or off a signal from the RF output connector. In the off mode, the key lamp lights on. When the reverse power protector operates by applying a reverse power, if this key is pressed following the Shift key, the device returns to the ordinary state.
17	Entry [GHz/wdBm], [MHz/dB μ], [kHz/mV], and [Hz/ μ V] keys	A unit key used to enter each parameter with a numeric value using the ten keys and decide the numeric value. Select a unit according to each input parameter and press an appropriate one.
18	Entry, [0] through [9], [-/+], and [BS] keys	Ten keys used to enter each parameter with a numeric value and backspace key used to erase an erroneously entered digit.
19	Entry [Shift] key	To operate a key displayed in blue characters on the panel, first press this key (its lamp lights on), then press the required key.
20	Entry [Frequency], [Level], [Modulation], and [Memory] keys	Header keys used to select the ten keys, step keys in the edit zone, or rotary knob function. Pressing one of four keys turns on its lamp and validates a value entered using the ten keys as a parameter. One lamp indicating the edit zone function then lights on and the step key and rotary knob function are selected. However, the Level key has the output level step key and rotary knob, and the edit zone function is not modified. Pressing the Frequency or Level key following the Shift key places each step key into the step size entry state. Then, use the ten keys and unit key to set a value. Pressing the Modulation key following the Shift key sets the memory set mode that enables to store and clear memory contents.
21	AF output connector	Outputs a signal of the modulation signal source with impedance 600 Ω .
22	Edit Step [^] and [v] keys	Steps up or down the parameter specified with the Entry key or on the multi-menu display.
23	Edit Rotary Knob Resolution [<] and [>] key	Specifies the rotary knob for varying the parameter specified with the Entry key or on the multi-menu display and its resolution. When the > key is pressed following the Shift key, the resolution of the rotary knob matches the step size of the step key, and the knob can be set up and down with an arbitrary level step size. (This function is valid only at setting of a frequency.)
24	Mod Input Ext1 and Ext2 connectors	An external modulation signal input connector. The appropriate input level is 2 Vp-p. If the input signal level is lower than that value, the “▲” lamp lights on; otherwise, the “▼” lamp lights on to notify that the input signal level is not appropriate.
25	Edit Frequency, Modulation, and Memory lamps	Indicate the parameter for which the rotary knob and step key in the edit zone are valid currently. All the lamps go off when a parameter is selected on the multi-menu display.

No	Name, display	Description
26	[Stby/On] switch	Switches the standby mode to the on mode and vice versa. The Stby lamp lights on in the standby mode; the On lamp lights in the on mode.
27	[Local] key	Returns to the local mode after remote control.
28	Remote lamp	Lights on at remote control.
29	[Preset] key	Initializes the mode set on the panel.
30	[Display] key	Turns off the multi-menu display to suppress the undesired radiation. Pressing this key following the Shift key enables to turn off all the displays excluding the On lamp and external modulation level indicators “▲” and “▼”. To turn on the multi-menu display again, perform the same procedure as the turn-off procedure.

3.1.2 Rear panel layout

This paragraph outlines the switches and connectors arranged on the rear panel.

No	Name, display	Description
31	Cooling fan	Exhausts the heat generated inside the MG3641A/MG3642A to the outside. Do not leave anything to obstruct the air flow around the fan.
32	Freq Adj trimmer	Fine-adjusts the frequency of the internal base oscillator .
33	GPIB connector	Used in GPIB remote control mode.
34	○ switch	Turns on or off all the power to the MG3641A/MG3642A.
35	AC power inlet	Inlet for AC power supply to the MG3641A/MG3642A.
36	FG terminal	Grounds the frame to the ground potential. This terminal must be grounded for safety.
37	Trig Input connector	When the trigger function is used, this connector is used to input the trigger signal.
38	Sweep Out connectors	Outputs an auxiliary sweep signal.
39	Int Mod Cont 1, 2, 3 connectors	When an internal modulation source option that needs to be controlled externally is mounted, one of these connectors is used to input the control signal. The function depends on the type of option mounted.
40	Pulse Mod Input connector	Inputs a pulse modulation signal. (Pulse Modulator is optional.)
41	10 MHz Buff Out connector	Outputs a signal of the frequency synchronized to the reference signal in the MG3641A/MG3642A.
42	5 MHz/10 MHz Ref In connector	Inputs the reference signal to synchronize the MG3641A/MG3642A with an external reference signal.

SECTION 3 PANEL LAYOUT

3.1.3 Panel layout diagram

Figures 3-1 and 3-2 show the front and rear panel diagrams, respectively.

The numbers in the diagrams correspond to those in the paragraphs 3.1.1 and 3.1.2.

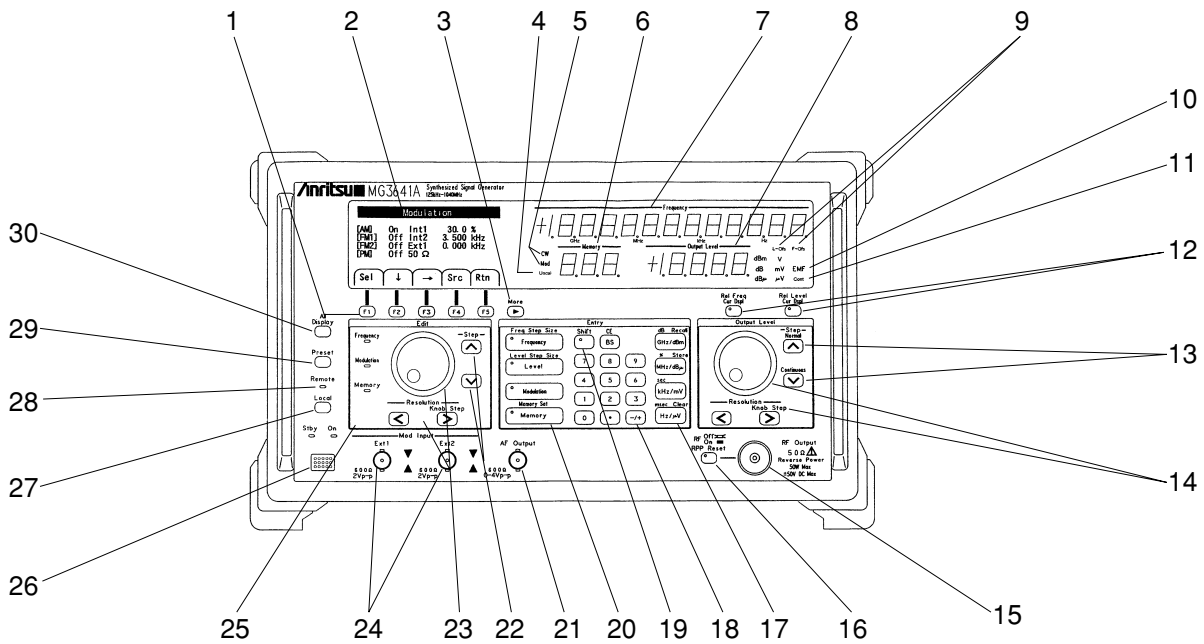

Fig. 3-1. Front Panel

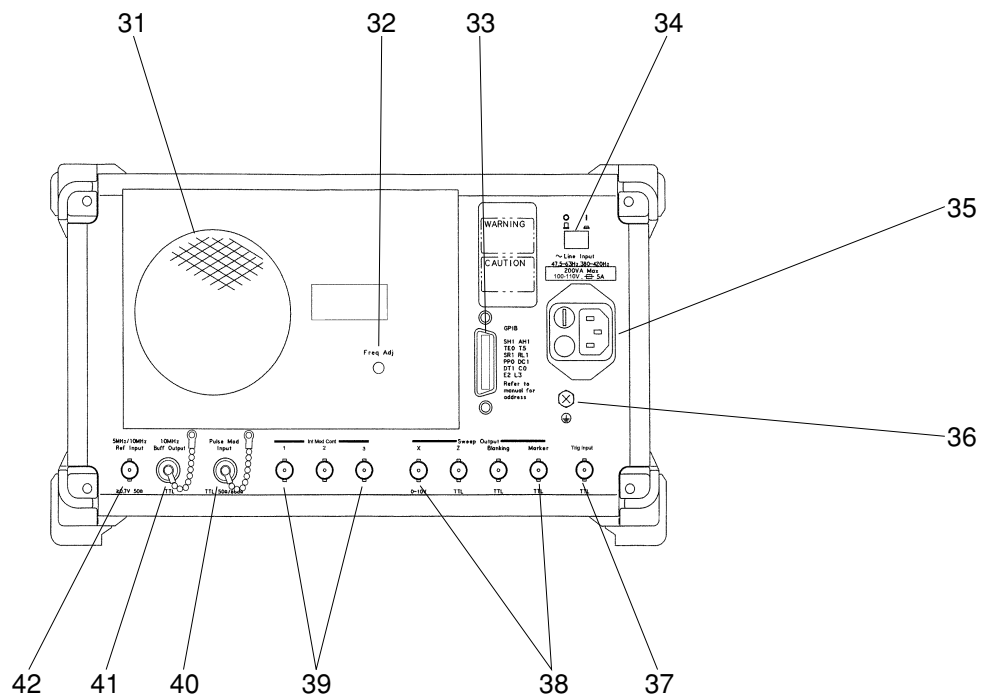

Fig. 3-2. Rear Panel

SECTION 4

OPERATING INSTRUCTIONS

4.1 Turning Power On/Off

The MG3641A/MG3642A comes provided with two power switches, namely, the "Stby/On" switch on the front panel and the "O |" switch on the rear panel.

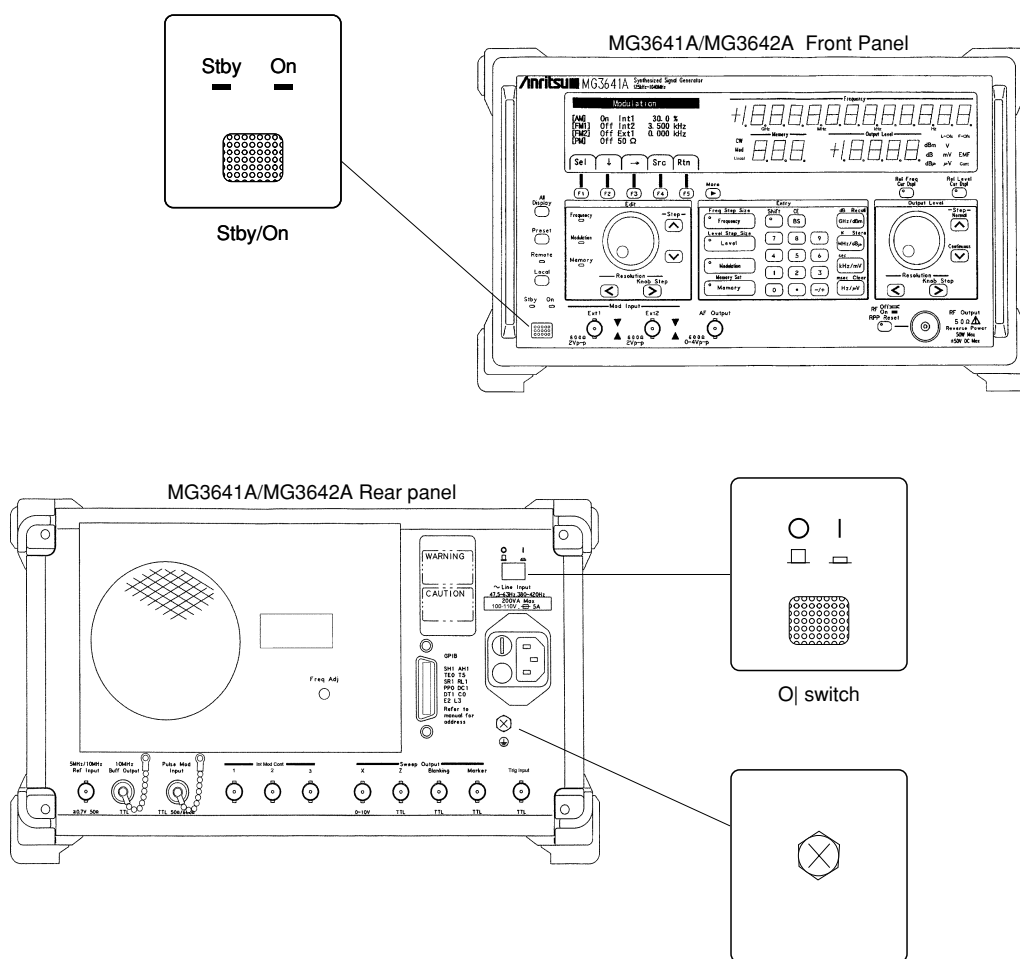

Frame ground terminal: To prevent electric shock, connect this terminal to ground potential.

DANGER ⚠

Turning power on without grounding protection could lead to a bodily injury due to electric shocks. Where a three-pole (2-pole for grounding type) current outlet is not available, make sure you connect the frame ground terminal (FG) located on the rear panel or the ground terminal of the accessory power cord to the ground potential, before you supply power to the MG3641A/MG3642A.

WARNING ⚠

In case the AC line voltage fed to the unit is not an appropriate one, the interior of the signal generator may be damaged because of abnormal voltages. Before switching on the MG3641A/MG3642A, check to make sure that the AC line voltage meets the specified value.





In normal operation of this signal generator, leave the "○ |" switch of the rear panel permanently set in the " | " position, with the accessory power cord plugged into the AC inlet and the current outlet, and control the on/off operations of the signal generator only by the "Stby/On" switch located on the front panel.

Table 4-1. Indications of Power Indicator Lamps and Power Statuses

Status of power switch		Status of power indicator lamp	
"○ " swich	"Stby/On" switch	"Stby" (Green)	"On" (Orange)
○	Stby	Unlit	Unlit
	Stby	Lit	Unlit
	On	Unlit	Lit

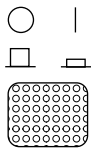
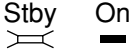
4.1.1 Turning Power On

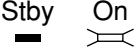
The procedure to be followed from preheating the internal reference oscillator, till operating the signal generator, will be explained below.

STEP	PROCEDURE
1.	<p>Connect the FG terminal located on the rear panel to ground.</p> <ul style="list-style-type: none"> If you use a 3-pole power cord fitted with a ground terminal, you do not have to do this grounding connection.
2.	<p>Place the "○ " switch on the rear panel in the "○" (Off) position.</p>  <ul style="list-style-type: none"> When this button is pressed and remains depressed, it is in the " " (On) position. To turn it off, bring the button up by pressing it again. When the button is turned off, the AC power is cut off, even if the power button on the front panel is set in the On position.
3.	<p>Plug the jack of the power cord into the AC power inlet on the rear panel.</p> <ul style="list-style-type: none"> Push in the jack of the power cord securely, till the clearance is reduced to 1 to 2 mm.
4.	<p>Insert the plug of the power cord into the AC current outlet.</p>
5.	<p>Turn on the "○ " switch on the rear panel.</p> <ul style="list-style-type: none"> The "Stby" lamp of the power switch on the front panel lights up. The preheating of the internal reference oscillator begins. To operate this signal generator after it has been exposed in a low-temperature ambient, preheat it for at least 24 hours.  
6.	<p>Press the "Stby/On" switch on the front panel to turn it on.</p> <ul style="list-style-type: none"> The "On" lamp of the power switch on the front panel lights up, while the "Stby" lamp goes out. The power will be supplied to all the circuits of the MG3641A/MG3642A, which gets ready for operation.  

Note : If neither of the power indicator lamps comes on, check the following points:

1. Is the power cord coupled correctly to the current outlet and the power plug?
2. Is the specified fuse installed correctly in the fuse-holder?
3. Is the supply voltage a correct one?

SECTION 4 OPERATING INSTRUCTIONS

4.1.2 Turning Power Off

To turn the power off, follow the same procedure detailed in Item 4.1.1 inversely.

4.2 Explanation of Screens

This signal generator is equipped with a multi-menu display for indicating statuses and setting operations, except for the major items, such as frequency, output level, memory, etc.

(1) Screen Layout

Displays the menu currently open.

Area for status display and setting operations.
A parameter can be set or a status selected at the location where the characters are highlighted.

Error message area. Indicates details of an operation error or other errors.

Function keys corresponding to the key menu shown on the display

Key to turn the page when a menu of the same layer goes over to multiple pages.

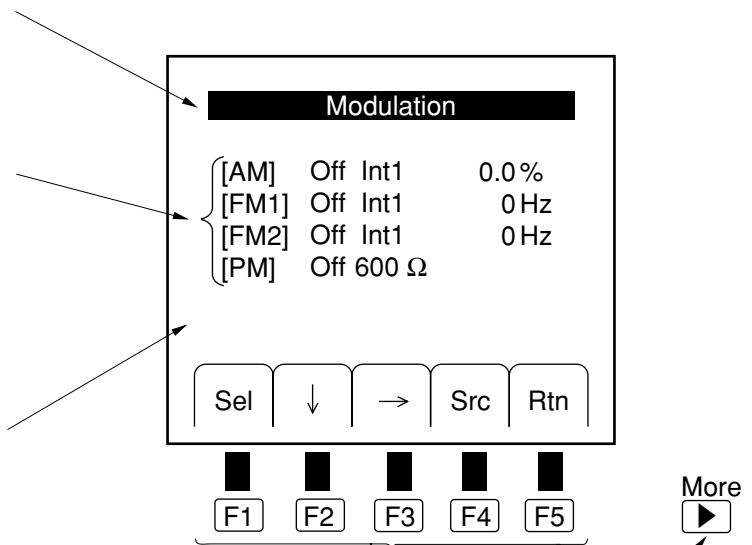

(2) Functions of Function Keys

The function keys have the following operational functions:

Sel Used when the currently highlighted parameter is a selection item. Each press to this key displays selection items successively.

↓, → Keys to select a parameter to be set.

By pressing these keys, you move the highlighted item in the direction of arrows.

Src A key to move to the menu of the next layer. (“Src” indicates a menu name.)

Rtn Return key to go back to the menu of the immediately higher layer.

4.3 Initial Settings

You can return the panel settings of the MG3641A/MG3642A to the initial setting conditions by pressing the [Preset] key.

The term "Initial Settings" as used herein refers to the conditions under which the signal generator was shipped out of the factory (Appendix A). However, if you alter the contents of the preset memory, you will be able to restore your desired initial conditions from any current panel settings.

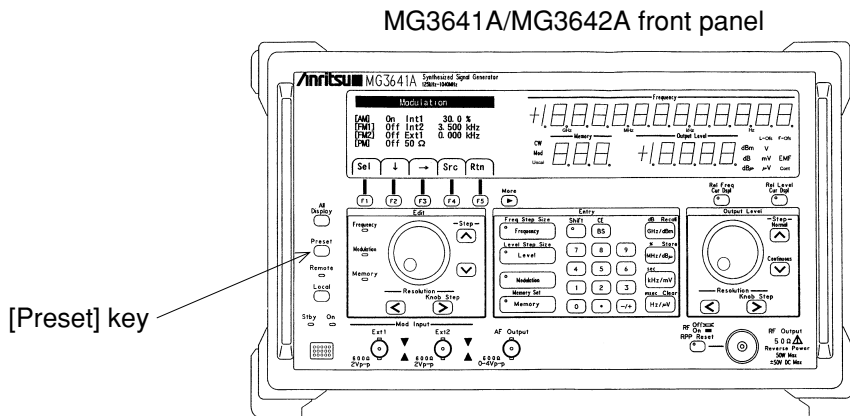

To alter the preset memory contents, first set up conditions you want to use as initial settings, and then follow the procedure detailed below:

- (1) Press the "Sys" [F3] key in the top menu to open the "System (1)" menu.

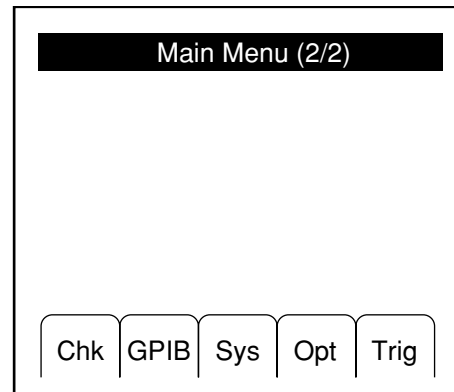

- (2) Select "Initial memory set" by pressing the "↓" [F2] key or "↑" [F3] key (the characters are highlighted).
- (3) As you press the "Sel" [F1] key, the current panel settings will be written to the preset memory.

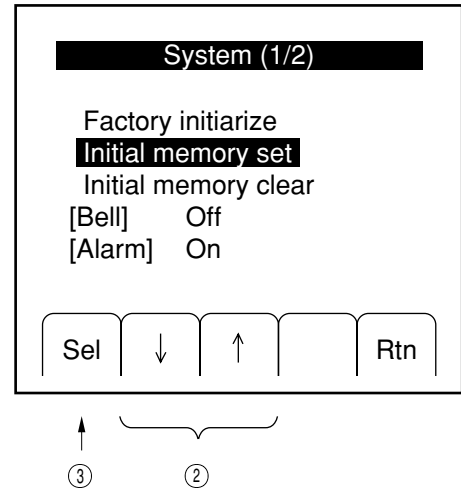

If you select "Initial memory clear" in (2) above, and press the "Sel" [F1] key, the contents of the preset memory will be cleared, and the factory settings will be restored.

Moreover, if you select "Factory initialize" and press the "Sel" [F1], the generator will be initialized with the factory settings. Be careful in this case, since the contents of the panel memory and all the system settings will be initialized.

4.4 Setting the Frequency

4.4.1 Setting the Frequency

You can set up a frequency by operating the number keys, step keys, and rotary knob.

Pressing the [Frequency] key in the Entry zone turns on the lamp of the [Frequency] key and the Frequency lamp in the Edit zone. This readies the unit for frequency setting to be made via the number keys, and the step keys and rotary knob in the Edit zone.

(1) Setting by number keys

You use the number keys to enter numeric values and units for setting.

(2) Setting by step keys

You use the step keys [v][^] to step up or down a frequency.

You enter a step size by operating the [Shift] key, [Frequency] (Freq Step Size) key, number keys, and the unit keys, in this order. The setting is completed the moment you press a unit key.

(3) Setting by rotary knob

Turning the rotary knob raises or lowers a frequency.

You select a resolution by the Resolution [<], [>] keys.

Moreover, you can "knob up" or "knob down" the step size you entered in (2) above by operating the [Shift] key and the [>] (Knob Step) key in this order.

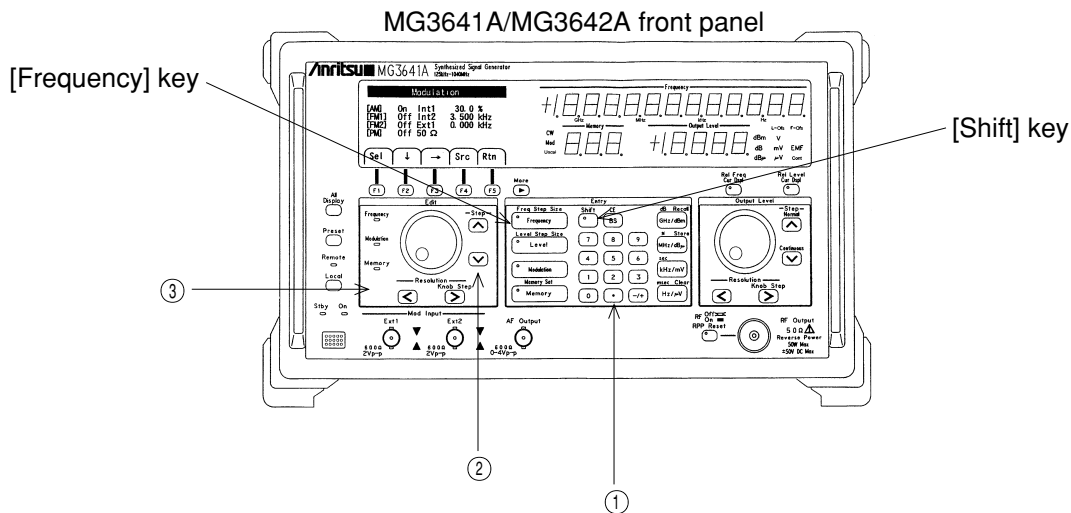

4.4.2 Displaying the Frequency Relative Value

To display a frequency in a relative value referred to the current frequency defined as reference (0 Hz), you press the [Rel Freq] key. The lamp of the key will come on, causing the Frequency indicator to display +0 Hz.

While a frequency relative value is on display, all frequency settings made via the number keys, step keys and the rotary knob will be treated as relative frequency settings.

To clear the frequency relative value display, turn the lamp off by pressing the [Rel Freq] key again.

If you need to verify the actual output frequency while a frequency relative value is on display, press the [Shift] key and, then, keep on holding down the [Rel Freq] (Cur Dspl) key. This will allow the actual output frequency to appear temporarily on the display.

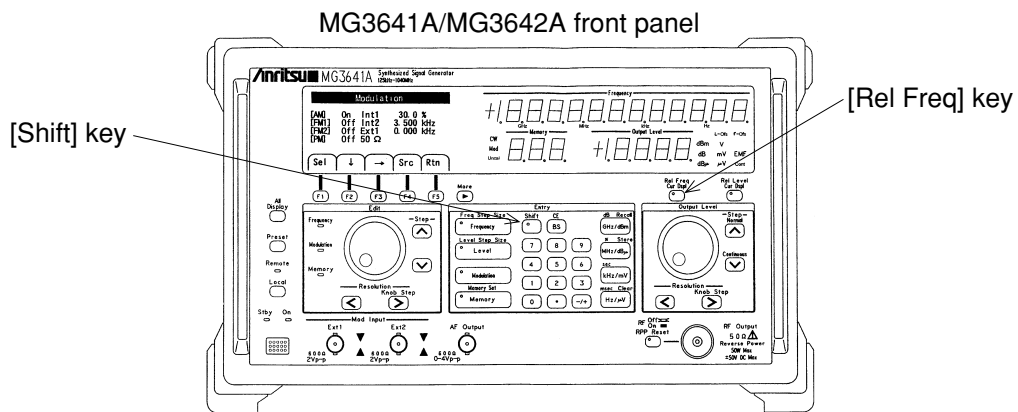

4.4.3 Frequency Offset

Frequency offset means a function to offset a set frequency and a displayed frequency against the frequency to be actually output.

When the frequency offset is activated, each frequency value will be expressed by the following equation:

$$[\text{Actual Frequency}] = [\text{Set/Displayed Frequency}] - [\text{Frequency Offset Value}]$$

For example, if you set the frequency to 1 GHz after setting the frequency offset value to +10 MHz, the display will indicate 1 GHz, but the actual output frequency will be 990 MHz.

To set a frequency offset value, follow the procedure detailed below:

- (1) Press the "Ofs" [F4] key in the main menu (1) to open the "Offset" menu.

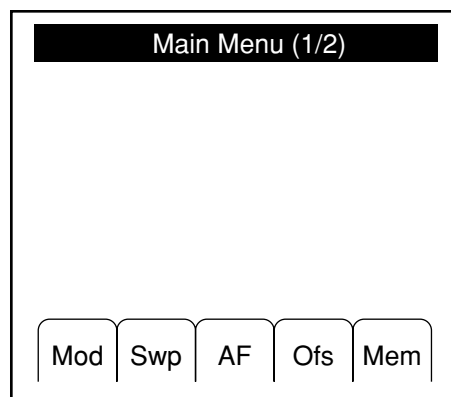

↑
①

- (2) Select "Frequency offset value" by pressing the "↓" [F2] key (the frequency value will be highlighted).
- (3) Set a frequency offset value by the number keys, and the step keys and rotary knob in the Edit zone.

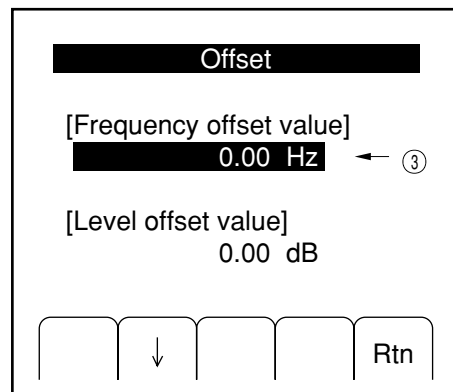

↑
②

While the frequency offset condition lasts, the characters "F-Ofs" appear on the Frequency indicator, indicating that the signal generator is in frequency offset state.

To clear the frequency offset state, you enter 0 Hz by following the procedure already described for setting a frequency offset value.

If you need to verify the actual output frequency while the frequency offset state continues, press the [Shift] key and, then, keep on holding down the [Rel Freq] (Cur Dspl) key. This will allow the actual output frequency to appear temporarily on the display.

4.5 Setting the Output Level

4.5.1 Setting the Output Level

You can set up an output level by operating the number keys, step keys and the rotary knob.

Pressing the [Level] key in the Entry zone turns on the [Level] key lamp, indicating that the unit is readied for setting an output level via the number keys.

Moreover, the step keys and the rotary knob in the Output Level zones can always be adjusted for an output level.

(1) Setting by number keys

You use the number keys to enter numeric values and units for setting.

If you press a unit key alone, without priorly entering any numeric value, the unit of the output level indication changes to that of the key.

(2) Setting by step keys

You use the step keys [^][v] to step up or down an output level.

You enter a step size by the [Shift] key, [Level] (Level Step Size) key, number keys, and the unit keys, in this order. The setting is completed the moment you press a unit key.

(3) Setting by rotary knob

Turning the rotary knob raises or lowers an output level.

You select a resolution by the Resolution [<], [>] keys.

Moreover, you can "knob up" or "knob down" the step size you defined in (2) above by operating the [Shift] key and the [>] (Knob Step) key in this order.

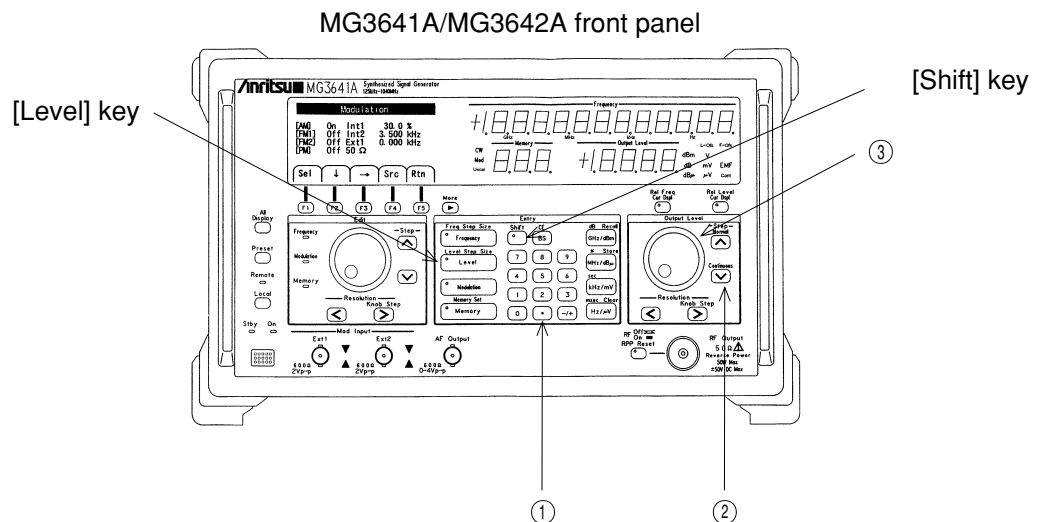

4.5.2 Displaying the Output Level Relative Value

To display a level in a relative value referred to the current output level defined as reference (0 dB), press the [Rel Level] key. The lamp of the key will come on, causing the Output Level indicator to display +0 dB.

When an output level relative value is on display, all output level settings made via the number keys, step keys and the rotary knob will be treated as relative level settings.

To clear the output level relative value display, turn the lamp off by pressing the [Rel Level] key again.

If you need to verify the actual output level while an output level relative value is on display, press the [Shift] key and, then, keep on holding down the [Rel Level] (Cur Dspl) key. This will allow the actual output level to appear on the display temporarily.

MG3641A/MG3642A front panel

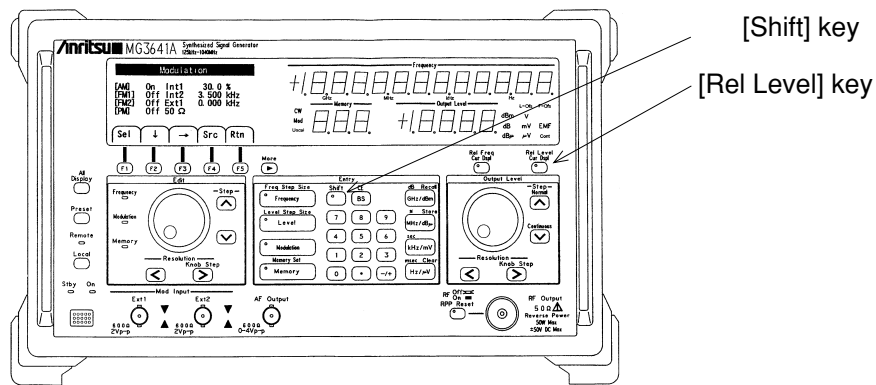

4.5.3 Output Level Offset

Output level offset means a function to offset a set level and a displayed level against the level to be actually output.

When the output level offset is activated, each level value will be expressed by the following equation:

$$[\text{Actual Level}] = [\text{Set/Displayed Level}] - [\text{Level Offset Value}]$$

For example, if you set the output level to -30 dBm after setting the level offset value to $+12$ dB, the display will indicate -30 dBm, but the actual output level will be -42 dBm.

To set a level offset value, follow the procedure detailed below:

- (1) Press the "Ofs" [F4] key in the main menu (1) to open the "Offset" menu.

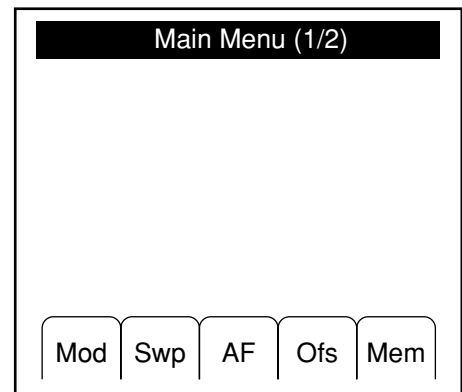

- (2) Select "Level offset value" by pressing the "↓" [F2] key (the level value will be highlighted).

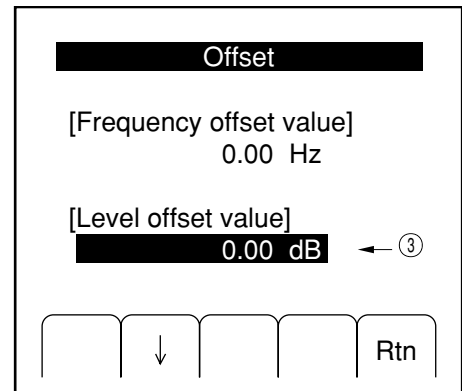

- (3) Set a level offset value via the number keys, and the step keys and rotary knob in the Edit.

When setting offset value via the rotary knob; at first change the value via rotary knob, then press the [Level] key, and at last press the unit key (dBm/dBμ) in this order. The setting is determined at pressing the unit key.

While the output level offset state last, the characters "L-Ofs" appear on the Output Level indicator, indicating that the signal generator remains in output level offset state.

To clear the output level offset, you enter 0 dB by following the procedure already described for setting an output level offset value.

If you need to verify the actual output level while the output level offset state continues, press the [Shift] key and, then, keep on holding down the [Rel Level] (Cur Dspl) key. This will allow the actual output level to appear temporarily on the display.

4.5.4 Level Continuous Mode

This signal generator employs a mechanical attenuator to vary the output level. For this reason, momentary signal interruptions and spike noise may be produced when you vary the output level.

Therefore, you select the level continuous mode in the cases where such momentary signal interruptions and spike noise pose particular problems in the measurements you are conducting.

When you activate the level continuous mode, the operation of the mechanical attenuator will be fixed, and you will be able to change the level continuously within a maximum range of ± 10 dB by using only the electronic attenuator designed for high-resolution setting.

(1) Setting the Level Continuous Mode

Press the [Shift] key and, then, the [v] (Continuous) key in the Output Level zone. The characters "Cont" will appear on the Output Level indicator, indicating that the continuous mode has been set up.

The output level setting range will be limited to ± 10 dB with its center at the level that existed when the continuous mode was activated, but you can vary the level within that range, free from momentary signal interruptions or spike noise.

(2) Clearing the Level Continuous Mode

Press the [Shift] key and, then, the [^] (Normal) key in the Output Level zone. The characters "Cont" will go out on the Output Level indicator, indicating that the continuous mode has been cleared.

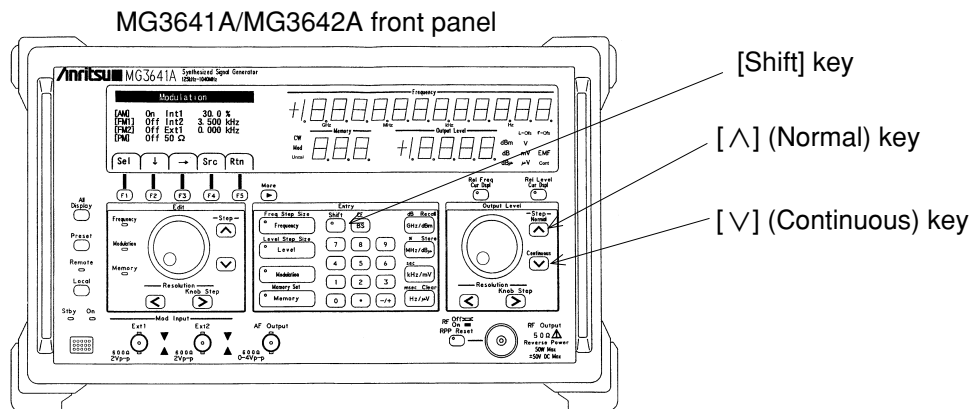

4.5.5 Switching the Output Signal On/Off

You can switch on and off the output signal that goes through the output connector by pressing the [RF Off/On] key. When the output signal is cut off, the lamp of the [RF Off/On] key will light up.

An output level you set with the output signal cut off will become effective the next time you switch on the output signal.

MG3641A/MG3642A front panel

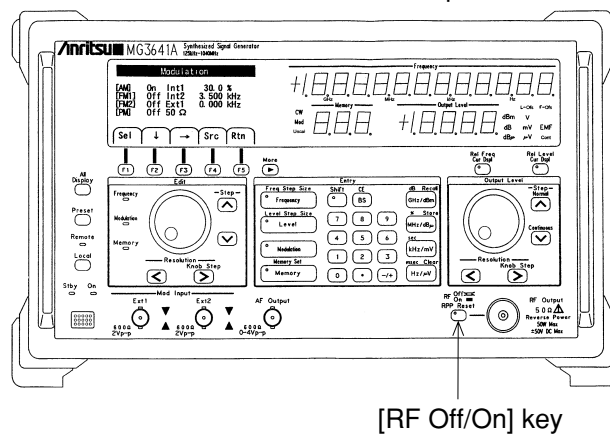

4.5.6 Special Functions Related to Level

The signal generator offers the following functions as special functions related to the setting of output levels. You activate these functions through the "System (2)" menu.

(1) Level Safety Mode

This unit uses a mechanical attenuator to vary the output level. For this reason, momentary signal interruptions and spike noise may be produced when you vary the output level.

In the measurements where a spike-like high level poses a particular problem, the level continuous mode described in Paragraph 4.5.4 will be a solution for you. However, if you need to vary the level over a wide range, you will have to opt for the level safety mode described in this paragraph.

This level safety mode requires that you once narrow the level and then set up a level again, before you can vary it. This necessarily involves momentary signal interruptions, and affects the level setting time, but does not give rise to spike-like high level.

(2) Display of voltage unit

The voltage of the output level is displayed in two ways: terminated-voltage display and open-voltage display.

The terminated-voltage display indicates a voltage that holds when a 50 Ω resistance is coupled to the output end, and the open-voltage display shows a voltage that exists when the output end is left open. The open voltage assumes a value twice that of the terminated voltage.

To execute a special function related to the output level, follow the procedure detailed below.

(3) Isolation mode

When using multiple signal generators with the summed output signal for the measurement of the inter-modulation distortion of an amplifier etc., the inter-modulation distortion of the summed output signal may disturb the measurement due to the interference between the signal-generator outputs of low isolation.

In this case, it is desired to increase the signal isolation between the signal generators for suppressing the distortion.

The MG3641A/MG3642A has the isolation mode to increase the isolation by increasing the attenuation amount of the last-output-stage circuit.

This isolation mode has the following advantages and disadvantages. Understand these features before use.

- Advantages: Improves intermodulation distortion.
Improves floor noise.
- Disadvantages: Deteriorates output level accuracy.
Deteriorates higher harmonic distortion.
Deteriorates AM modulation characteristics.

- (1) Press the "Sys" [F3] key in the main menu (2) to open the "System (1)" menu.
- (2) Press the [More] key to move on to the "System (2)" menu.
- (3) Select "Voltage unit", "Level mode" or "Isolation mode" by pressing the "↓" [F2] key or "↑" [F3] key (the status display will be highlighted).
- (4) Press the "Sel" [F1] to change the setting.

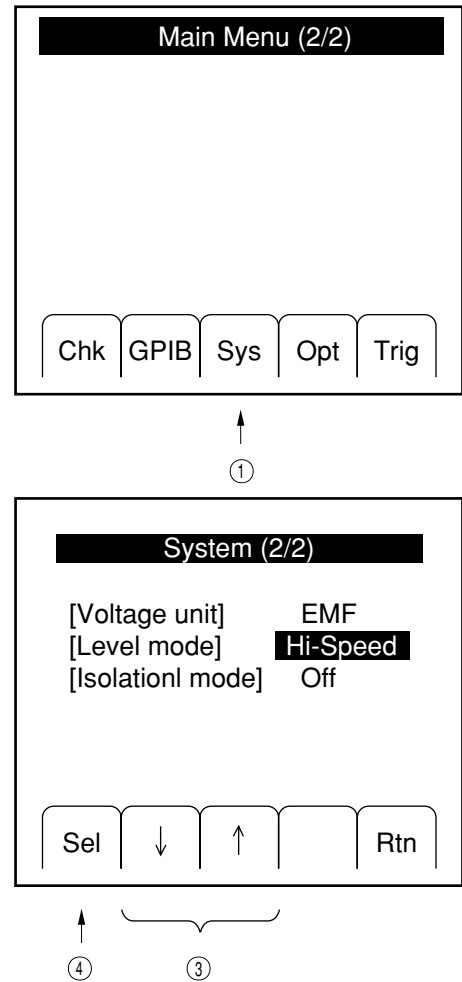

4.6 Setting the Modulation

4.6.1 Outline of Modulation

This signal generator provides AM and FM modulation functions. The FM modulation has two systems: FM1 and FM2, frequency deviation of which can be set independently of each other.

This unit also comes with 5 different modulation signal sources, as shown below, and you can select any one of them for each type of modulation.

- Internal modulation : Int1 Sine wave of 1 kHz or 400 Hz
- Int2 0.01 Hz to 400 kHz digital synthesizer
- Int3 0.01 Hz to 400 kHz digital synthesizer
- External modulation : Ext1 Signal supplied to the Mod Input Ext1 connector
- Ext2 Signal supplied to the Mod Input Ext2 connector

The flow of modulation signals is graphically presented below:

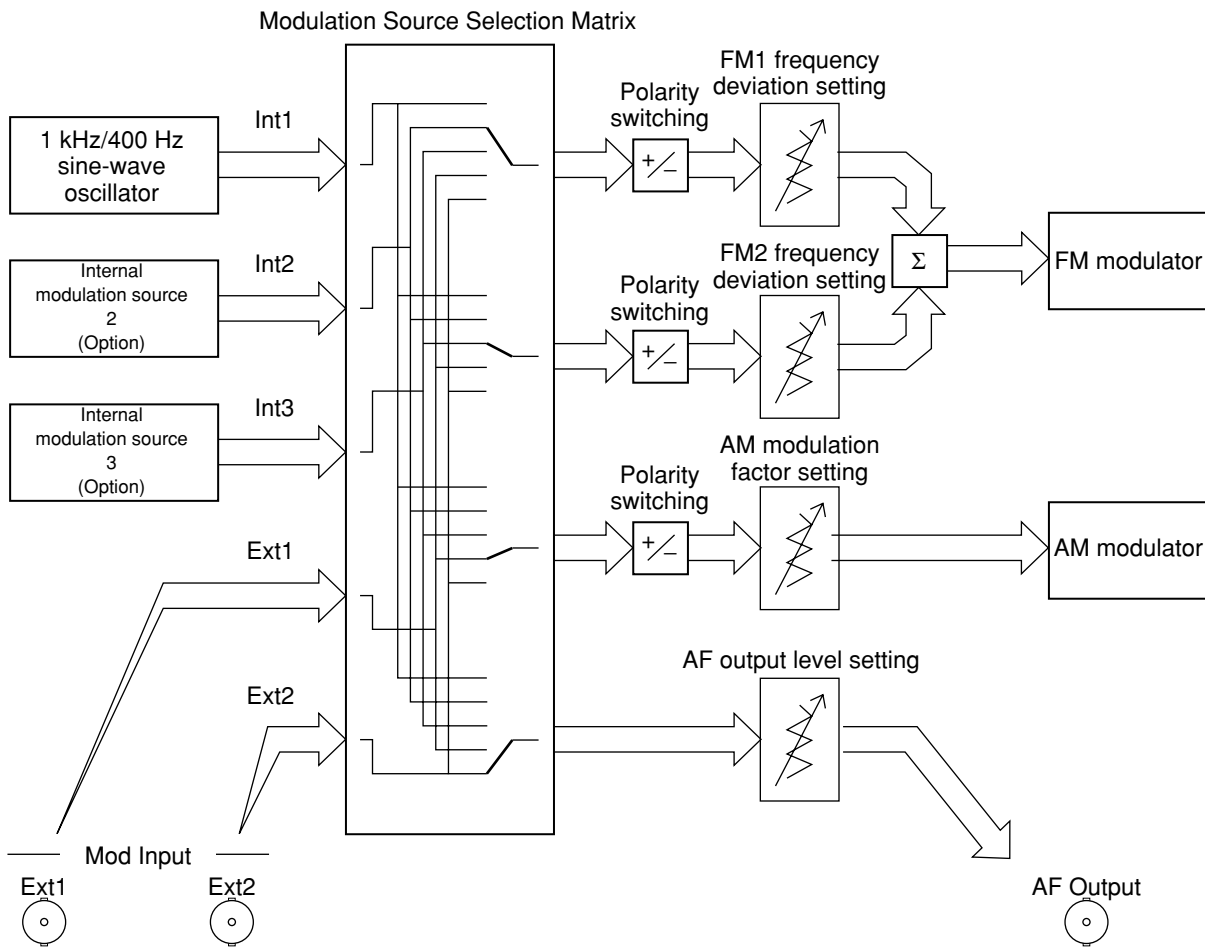

Flow of Modulation Signals

4.6.2 Setting the Modulation Function

You select activation/deactivation of each modulation type and a modulation signal source always through the "Modulation" menu.

- (1) Press the [Modulation] key or Main Menu (1) "Mod" [F1] key to open the "Modulation" menu.

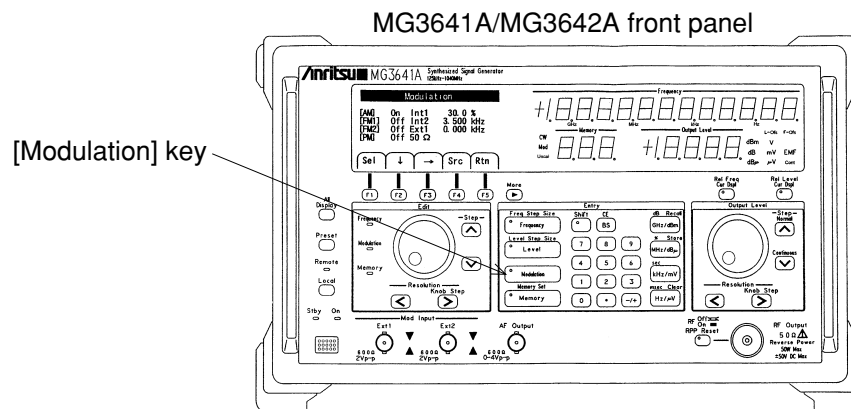

- (2) Select the set item you need to change by operating the "↓" [F2], and "→" [F3] keys (the characters are highlighted).
- (3) Press the "Sel" [F1] key to change the current setting.
 - Modulation function: On/Off
 - Modulation signal source: Int1/Int2/Int3/Ext1/Ext2

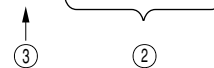
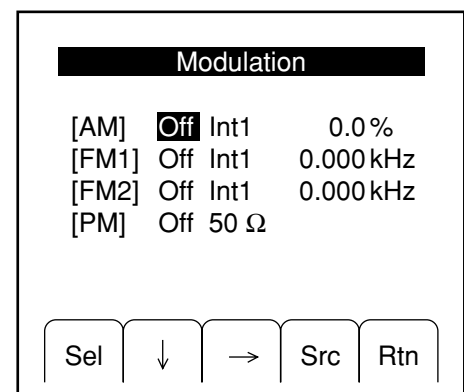

4.6.3 Setting the Modulation Factor and Frequency Deviation

You set an AM modulation factor or FM frequency deviation by operating the number keys, step keys and the rotary knob.

Pressing the [Modulation] key in the Entry zone turns on the lamp of the [Modulation] key and the Modulation lamp of the Edit zone, allowing to set an AM modulation factor or FM frequency deviation via the step keys and rotary knob in the Edit zone.

You select an AM modulation factor or FM frequency deviation in the "Modulation" menu opened by pressing the [Modulation] key. The AM modulation factor or FM frequency deviation set in this way is applied to the modulation of the item currently selected. Therefore, select a modulation function after moving the set item.

(1) Setting by number keys

You use the number keys to enter numeric values and units.

(2) Setting by step keys

You operate the step keys [^][v] to step up or down an AM modulation factor or FM frequency deviation.

The step size becomes as follows for each modulation:

- AM modulation factor : The step size is fixed to 10 %.
- FM frequency deviation : A frequency deviation is doubled by a step-up increment, or reduced to 1/2 by a step-down decrement.

(3) Setting by rotary knob

Turning the rotary knob raises or lowers the AM modulation factor or FM frequency deviation.

The resolution assumes the lowest position of the display both in AM modulation factor and FM frequency deviation.

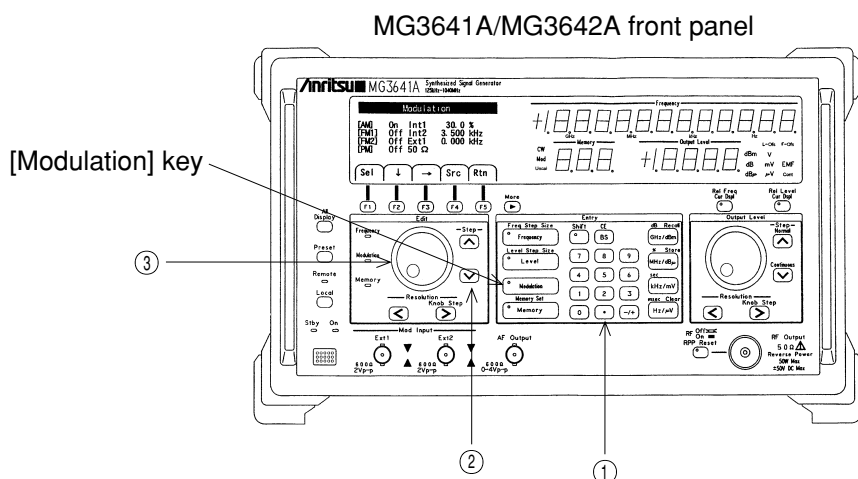

4.6.4 Setting Range of FM Frequency Deviation

In setting an FM frequency deviation, you can set it up to maximum 2048 kHz, irrespective of the output frequency. However, the actual FM frequency deviation is restricted by the output frequency, as shown in the table below. If you make a setting in excess of this limit, the "Uncal" lamp will come on, indicating that the range was surpassed, and, at the same time, the deviation will be set to the maximum value of the FM frequency deviation range corresponding to the current output frequency.

Output Frequency		FM Frequency Deviation Range	
≥125 kHz,	<250 kHz	0 to	125 Hz
≥250 kHz,	<500 kHz	0 to	250 Hz
≥500 kHz,	<1 MHz	0 to	500 Hz
≥1 MHz,	<2 MHz	0 to	1 kHz
≥2 MHz,	<4 MHz	0 to	2 kHz
≥4 MHz,	<8 MHz	0 to	4 kHz
≥8 MHz,	<16 MHz	0 to	10 kHz
≥16 MHz,	<32 MHz	0 to	25.6 kHz
≥32 MHz,	<64 MHz	0 to	51.2 kHz
≥64 MHz,	<128 MHz	0 to	102 kHz
≥128 MHz,	<256 MHz	0 to	256 kHz
≥256 MHz,	<512 MHz	0 to	512 kHz
≥512 MHz,	≤1040 MHz	0 to	1024 kHz
>1040 MHz,	≤2080 MHz	0 to	2048 kHz

4.6.5 Polarity of Modulation Signal

You can switch the polarity of modulation signals independently for each type of modulation.

Modulation signals are usually of non-inverted polarity. Yet, they invert the polarity as you set an AM modulation factor or FM frequency deviation in a negative value through the number keys.

For example, if you set the AM modulation factor to -30 %, you obtain an AM of 30 % modulation factor with modulation signals in inverted polarity.

The inversion and non-inversion cannot be switched by the step keys or rotary knob.

SECTION 4 OPERATING INSTRUCTIONS

4.6.6 Pulse Modulation

The pulse modulator (an option) can be built into the MG3641A/MG3642A.

The pulse modulator can apply modulation with TTL level signals applied to the "Pulse Mod Input" connector. It works fixed at positive logic, and the input impedance can be selected between 50 Ω and 600 Ω.

Set up the pulse modulation through the "Modulation" menu, as in the case with AM and FM.

MG3641A/MG3642A rear panel

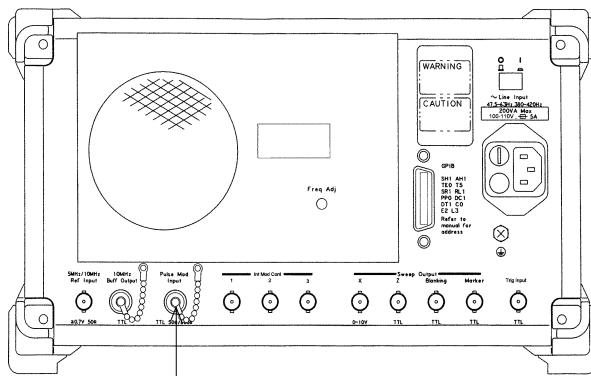

Pulse Mod Input connector

- (1) Press the [Modulation] key to open the "Modulation" menu.

MG3641A/MG3642A front panel

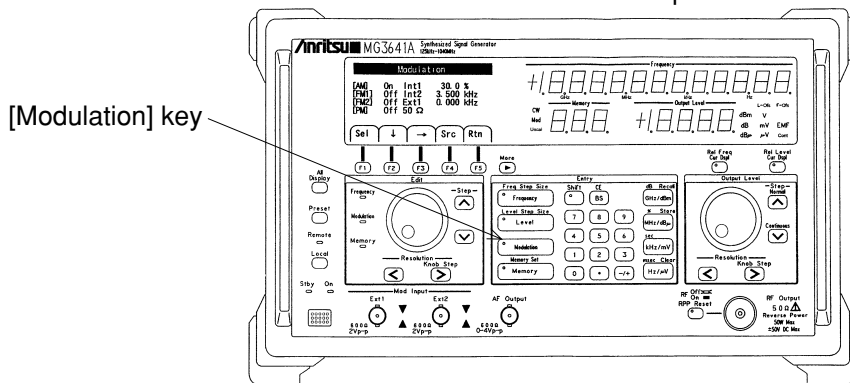

- (2) Select the item you need to change (ON/OFF or impedance) in the "PM" line by the "↓" [F2], and "→" [F3] keys (the characters are highlighted).
- (3) Press the "Sel" [F1] key to change the setting.
- Modulation function: On/Off
 - Impedance: 50 Ω/600 Ω

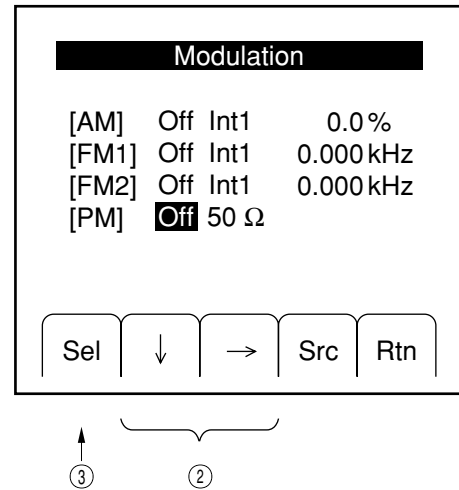

CAUTION

If the pulse modulation and AM are activated simultaneously, the AM modulation will not be applied normally. Feeding a voltage higher than +8 V or lower than -3 V to the "Pulse Mod Input" connector could result in breakdown of the unit. Be careful to prevent a voltage outside the limits from entering the unit.

4.7 Setting the Modulation Signal Source

4.7.1 Internal Modulation Signal (Int1)

Int1 is a signal source that generates sine waves at a frequency of either 1 kHz or 400 Hz.

To select a frequency for Int1, follow the procedure detailed below:

- (1) Press the "Src" [F4] key in the Modulation Menu to open the "Audio Source" menu.

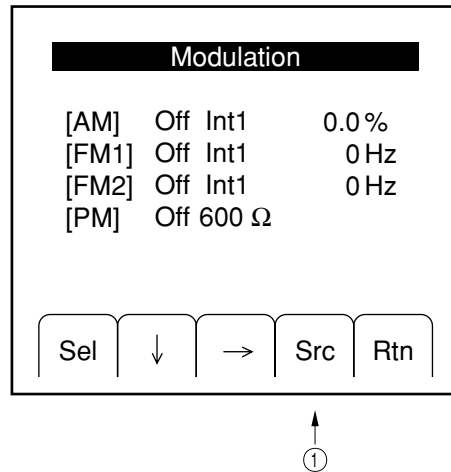

- (2) Select frequency display for Int1 by operating the "↓" [F2], and "↑" [F3], "→" [F4], keys (the characters are highlighted).
- (3) Press the "Sel" [F1] key to select 400 Hz or 1 kHz.

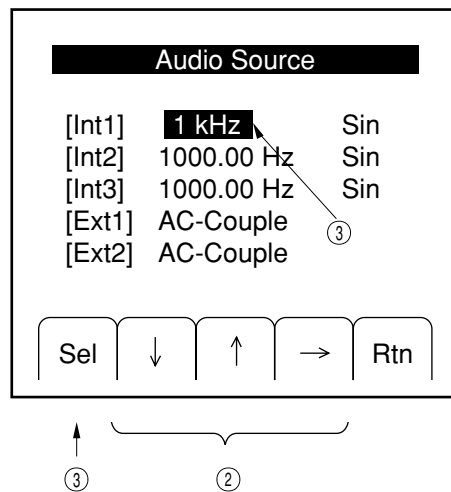

4.7.2 Internal Modulation Signals (Int2, Int3)

Int2 and Int3 are options. The following description of Int2 and Int3 assumes that AF Synthesizer (opt21) is mounted in them both. If another option is mounted, follow the operation description in the operation manual of that option.

AF Synthesizer are digital synthesizers that are capable of generating sine waves, triangular waves, sawtooth waves and square waves at any frequency.

To set up a frequency and waveform, follow the procedure detailed below:

- (1) Press the "Src" [F4] key in the Modulation Menu to open the "Audio Source" menu.

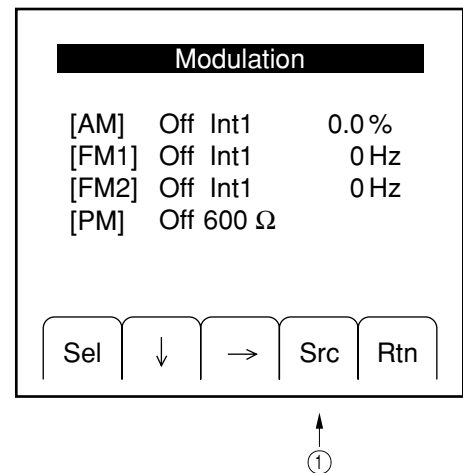

- (2) Select frequency display for Int2 or Int3 by operating the "↓" [F2], "↑" [F3], and "→" [F4] keys (the characters are highlighted), and set up a frequency by the step keys or the rotary knob in the Edit zone, and number keys.
- (3) Select waveform display for Int2 or Int3 by operating the "↓" [F2], "↑" [F3], and "→" [F4] keys (the characters are highlighted), and press the "Sel" [F1] key to select a waveform.

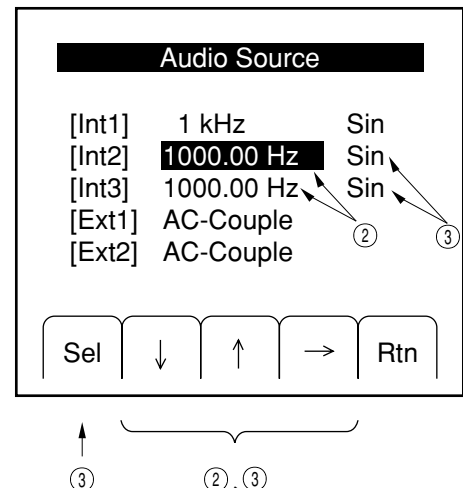

When you set a frequency via the step keys, the step size will be equal to the resolution position on the rotary knob. Select the position by which you want to step up or step down by the Resolution [<] and [>] keys.

4.7.3 External Modulation Signals (Ext1, Ext2)

Ext1 and Ext2 apply modulation using external signals supplied to the "Ext1" and "Ext2" connectors (600 Ω impedance) of Mod Input on the front panel.

The AM modulation factor or FM frequency deviation matches the relevant preset value, when the external signals applied to the "Ext1" and "Ext2" connectors assume a level of 2 Vp-p. Adjust the external signal level in such a manner that the "▲" and "▼" lamps located to the right of the "Ext1" and "Ext2" connectors, respectively, will both go out.

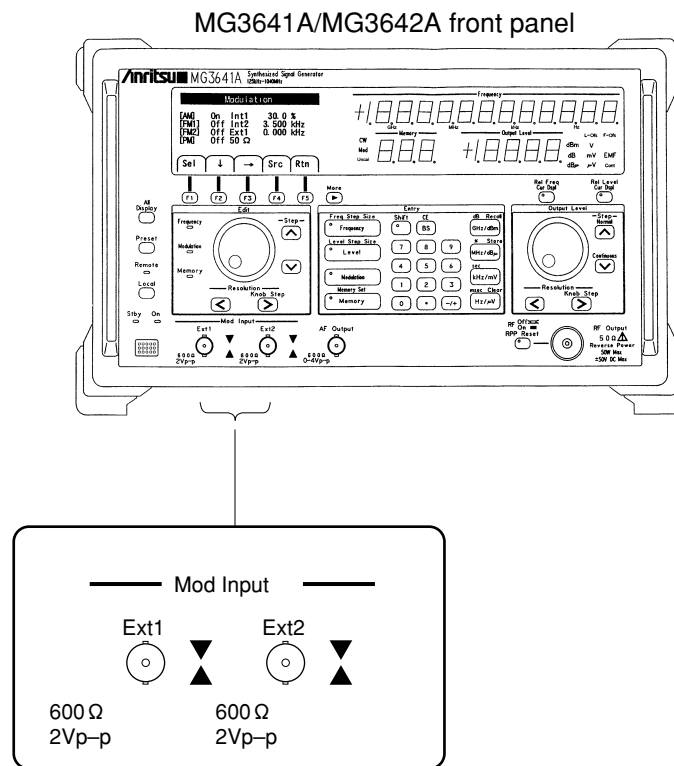

If the ▲ lamp lights: The input level is too low. Raise the input level.

If the ▼ lamp lights: The input level is too high. Lower the input level.

If the frequency of the modulation input signal is 100 Hz or less, adjust the signal level so that ▲ and ▼ alternately turns ON.

For the external modulation input, you can select either DC coupling or AC coupling by following the procedure detailed below:

- (1) Press the "Src" [F4] key in the Modulation menu to open the "Audio Source" menu.

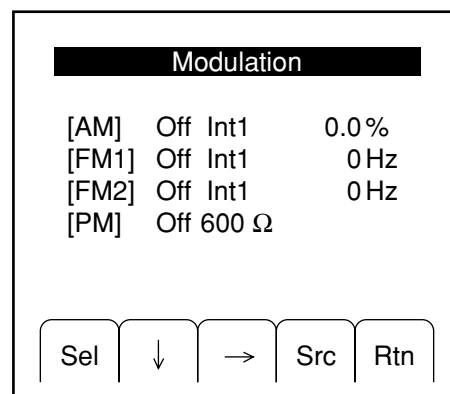

①

- (2) Select coupling display for Ext1 or Ext2 by operating the "↓" [F2], "↑" [F3], and "→" [F4] keys (the characters are highlighted).
- (3) Press the "Sel" [F1] key to change the setting.

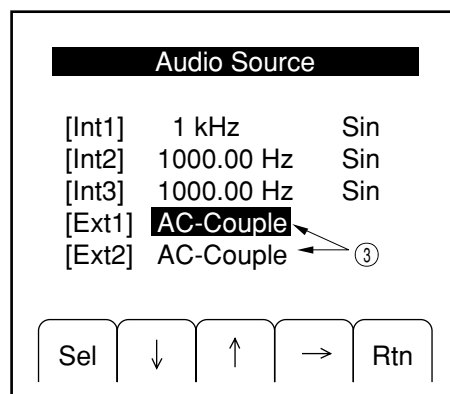

③

②

CAUTION

Applying a signal at a voltage higher than ± 10 V to the "Ext1" or "Ext2" connector could result in breakdown of the unit. Be careful to prevent a signal level outside the limits from entering the unit.

4.8 Setting the AF Output

Any one out of the internal modulation signals (Int1, Int2, Int3) and external modulation signals (Ext1, Ext2) of the modulation signal sources can be delivered through the "AF Output" connector on the front panel.

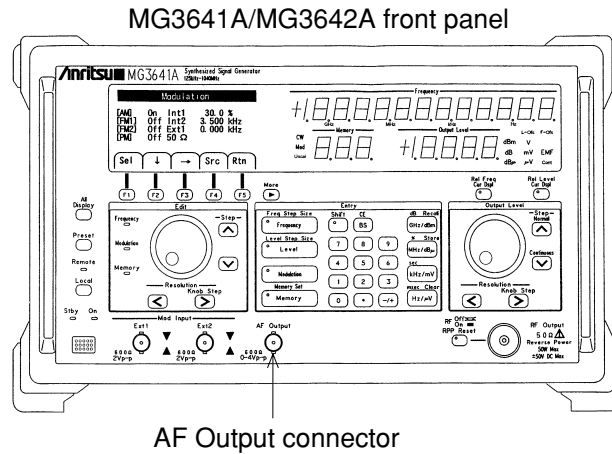

You select a signal source to supply signals from by following the procedure detailed below:

- (1) Press the "AF" [F3] key in the top menu to open the "AF Output" menu.

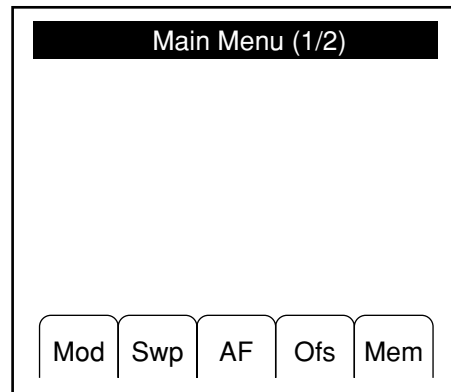

↑
①

- (2) Select "Source" by pressing the "↓" [F2] key (the characters are highlighted), and hold down the "Sel" [F1] key to select the signal you want delivered.
- (3) Press the "↓" [F2] key to select "Level" (the characters are highlighted), and set the AF output level by the number keys, and the set keys and rotary knob in the Edit zone.

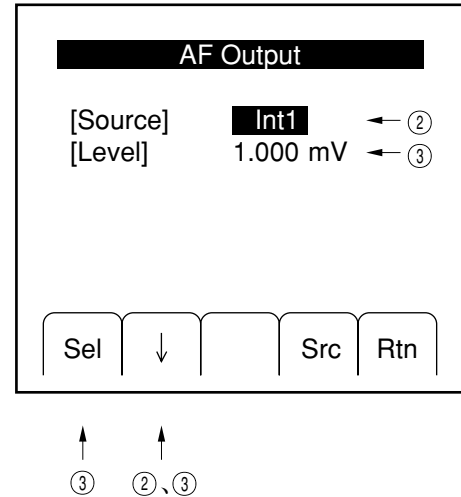

When you set an AF level via the step keys, the step size will be equal to the resolution on the rotary knob. Select the position by which you want to step up or step down by operating the Resolution [<] and [>] keys.

Since the "AF Output" connector has an output impedance of 600 Ω , the level you have set here will be the one corresponding to a termination with 600 Ω .

4.9 Memory Functions

4.9.1 Outline of Memory Functions

This signal generator comes with a memory function capable of storing 1000 different panel settings. The memories are assigned to addresses from 000 to 999, and are divided into 20 blocks, each consisting of 50 memories, as indicated below:

Block 1:	Memory address 000 to 049	Block 2:	Memory address 050 to 099
Block 3:	Memory address 100 to 149	Block 4:	Memory address 150 to 199
Block 5:	Memory address 200 to 249	Block 6:	Memory address 250 to 299
Block 7:	Memory address 300 to 349	Block 8:	Memory address 350 to 399
Block 9:	Memory address 400 to 449	Block 10:	Memory address 450 to 499
Block 11:	Memory address 500 to 549	Block 12:	Memory address 550 to 599
Block 13:	Memory address 600 to 649	Block 14:	Memory address 650 to 699
Block 15:	Memory address 700 to 749	Block 16:	Memory address 750 to 799
Block 17:	Memory address 800 to 849	Block 18:	Memory address 850 to 899
Block 19:	Memory address 900 to 949	Block 20:	Memory address 950 to 999

Normally, these divided memories can be handled as a series of 1000 memories, without this division being noticed in particular. However, when you recall memory contents continuously via the rotary knob or step keys, some memories can be excluded from the recall by blocks.

One memory recalling mode lets you recall frequencies only, or frequencies and output levels only. This allows to make the memory recall faster.

4.9.2 Storing in the Memory

To store settings in the memory, first establish the panel settings in the way you want stored and, then, follow the procedure below:

[Shift] key, [Memory] (Memory Set) key, number keys, and [MHz/dBμ] (Store) key.
(Address)

Enter an address in not more than 3 digits. Address 001 may be entered in either of the following forms: [0][0][1], [0][1] or [1].

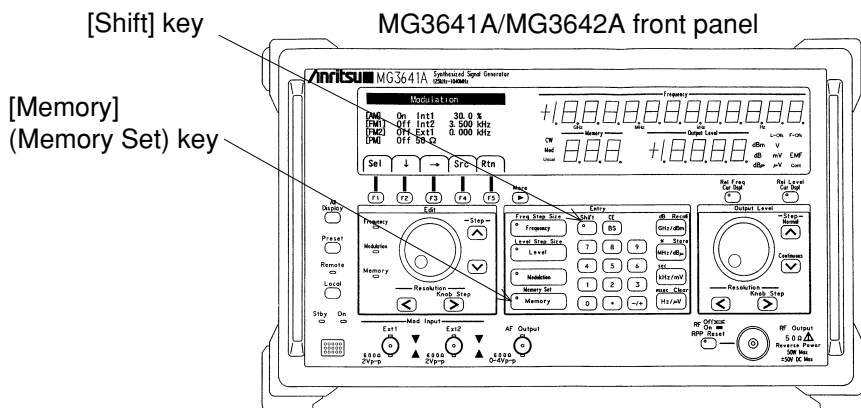

4.9.3 Recalling Memory Contents

You can recall memory contents by operating the number keys, step keys, and the rotary knob.

Pressing the [Memory] key in the Entry zone turns on the lamp of the [Memory] key and the Memory lamp in the Edit zone, leaving the unit ready to recall memory contents via the number keys, and the step key and rotary knob in the Edit zone.

(1) Setting by number keys

You recall memory contents by entering numeric values (address) via number keys and the [GHz/dBm] (Recall) key.

(2) Setting by step keys

You operate the step keys [^][v] to step up or down memory addresses already stored in order to recall memory contents continuously.

If any memory block was excluded from the continuous recall, all the memories of that block are skipped, and those of the following block are recalled.

(3) Setting by rotary knob

Turning the rotary knob raises or lowers memory addresses already stored to perform memory recall continuously.

If any memory block was excluded from the continuous recall, all the memories of that block are skipped, and those of the following block are recalled.

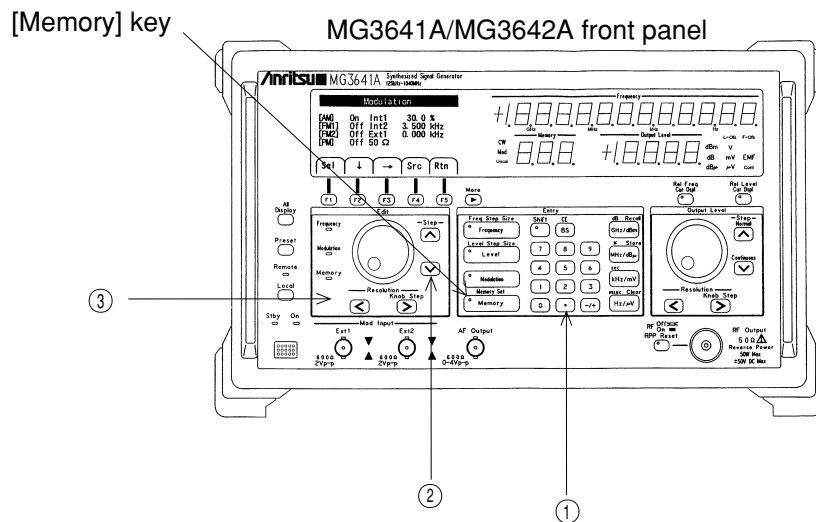

SECTION 4 OPERATING INSTRUCTIONS

To alter the attributes of memory blocks, follow the procedure detailed below:

- (1) Press the "Mem" [F5] key in the top menu to open the "Memory Block Select" menu.

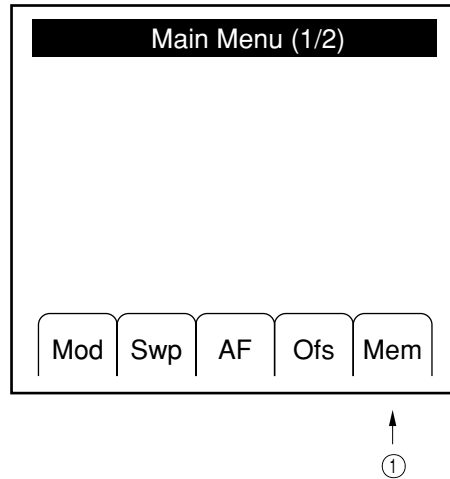

- (2) Select the memory block of which attributes you need to change, by pressing the "↓" [F2] key or "↑" [F3] key (the characters are highlighted). (To select a memory block not displayed, press the [More] key to bring it up on the display.)

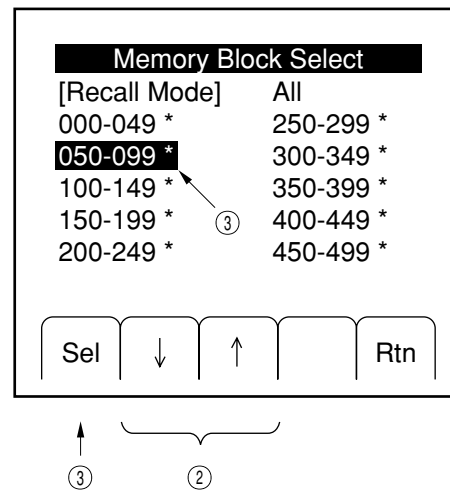

- (3) Press the "Sel" [F1] key to change the attribute. Memory addresses marked * are included in the continuous memory recall. They can be excluded from the continuous recall when you erase their "*".

4.9.4 Clearing the Memory

To clear memory contents, follow the keystrokes shown below:

[Shift] key, [Memory] (Memory Set) key, number keys, [Hz/ μ V] (Clear) key
Address

Or, to clear memories at continuous addresses in one shot, operate the keys as follows:

[Shift] key, [Memory] (Memory Set) key, number keys, [-] key, number keys, [Hz/ μ V] (Clear) key

Smallest address of the memory to be cleared	Largest address of the memory to be cleared
---	--

Enter an address in not more than 3 digits. Address 001 may be entered in either of the following forms: [0][0][1], [0][1] or [1].

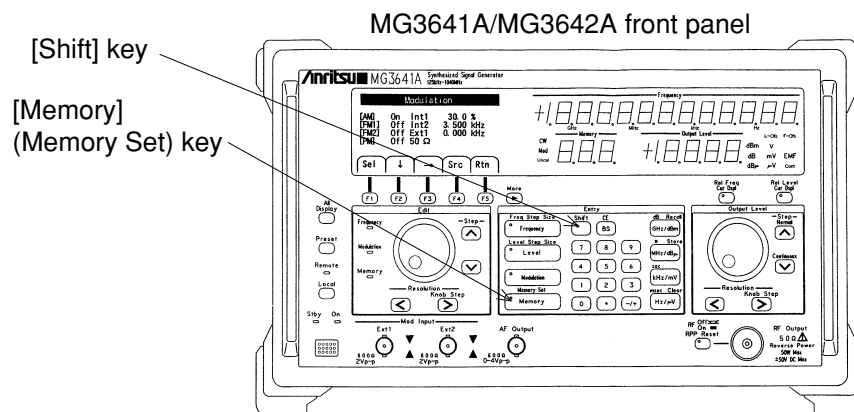

4.9.5 Selecting the Memory Recall Mode

If you limit the memory contents to be recalled to frequencies only or frequency and output levels only, you can execute high-speed memory recall, without changing other settings (modulation, for example).

Select a memory mode by following the procedure detailed below:

- (1) Press the "Mem" [F5] key in the top menu to open the "Memory Block Select" menu.

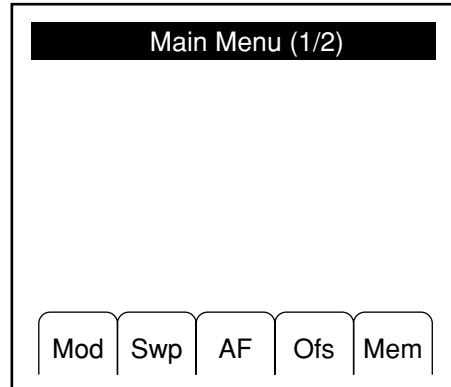

↑
①

- (2) Select "Recall Mode" by pressing the "↓" [F2] key or "↑" [F3] key (the state is highlighted).

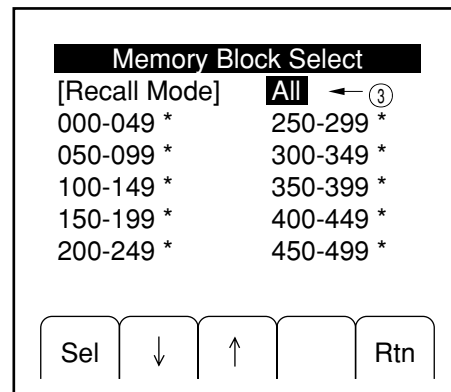

↑ }
③ ②

- (3) Select a recall mode by the "Sel" [F1] key.
 - All : To recall all the panel settings
 - Freq : To recall frequencies only
 - Freq&Level : To recall frequencies and output levels

4.10 Sweep Functions

4.10.1 Outline of Sweep Functions

This signal generator performs sweep with respect to the frequencies, output levels, and memories. Each sweep has the following sweeping patterns:

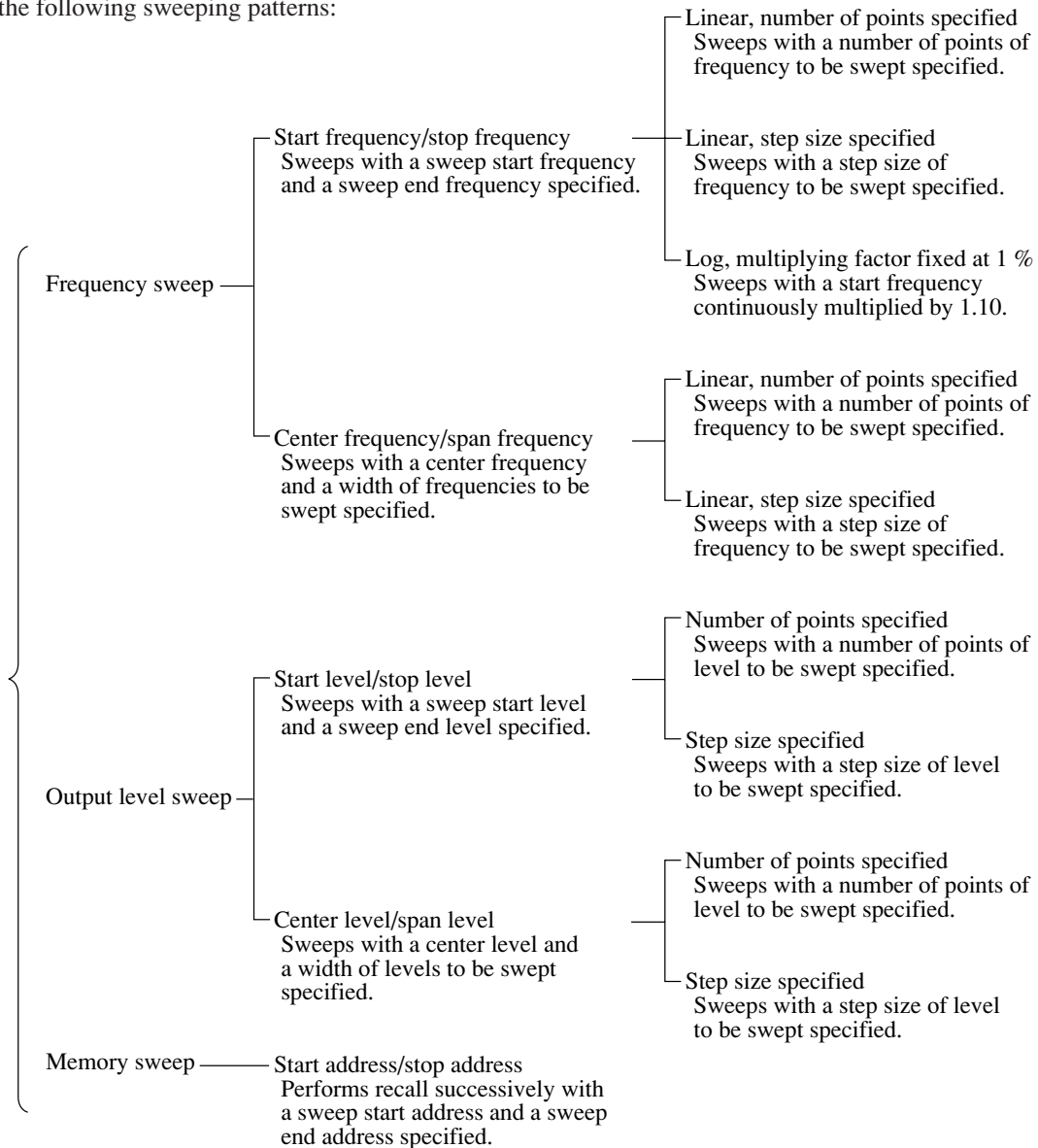

Moreover, this unit provides 3 different sweep modes, as follows:

- AUTO ... Sweeps repetitively from sweep start point to sweep end point.
- SINGLE ... Sweeps just once from sweep start point to sweep end point.
- MANUAL ... Sweep is activated manually via the rotary knob, in accordance with a sweep pattern.

You execute sweep after selecting a sweep pattern and setting sweep parameters. All the sweep functions can be set through the "Sweep" menu.

4.10.2 Setting and Executing the Sweep

In the first place, you select a sweep pattern by following the procedure detailed below:

- (1) Press the "Swp" [F2] key in the top menu to open the "Sweep" menu.

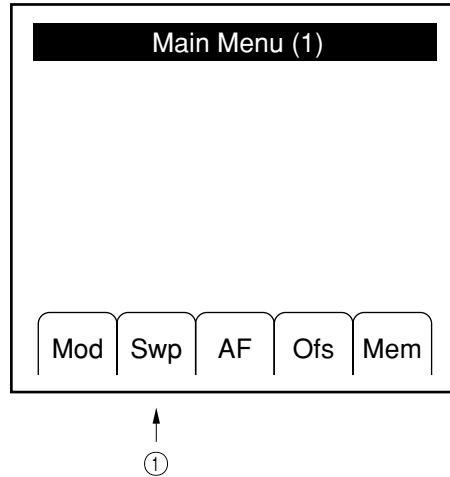

- (2) Press the "Sel" [F1] key to select the sweep pattern menu.

The menus will open in the following order:

- Frequency sweep (Start/Stop)
- ↓
- Frequency sweep (Center/Span)
- ↓
- Level sweep (Start/Stop)
- ↓
- Level sweep (Center/Span)
- ↓
- Memory sweep

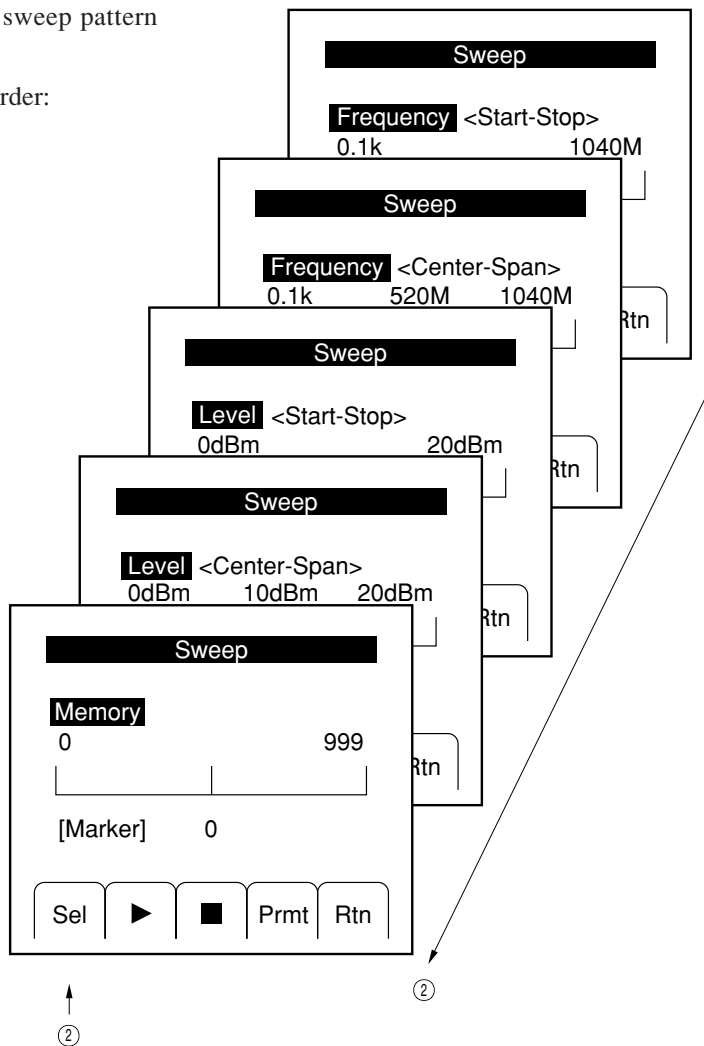

Then, you set up sweep parameters. The following explanation assumes that the frequency sweep (Start/Stop) was selected for the sweep pattern.

- (3) Press the "Prmt" [F4] key in the "Sweep" menu to open the "Sweep Parameter (1)" menu.

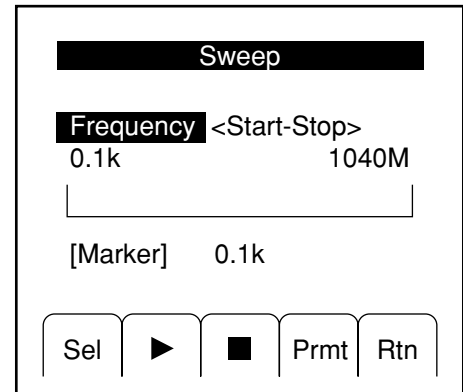

↑
③

- (4) Select the sweep parameter item to be changed, by pressing the "↓" [F2] key or "↑" [F3] key (the characters are highlighted). If the parameter item is a numeric value, operate the number keys and the step keys and rotary knob in the Edit zone to set the value.
To select a status, press the "Sel" [F1].

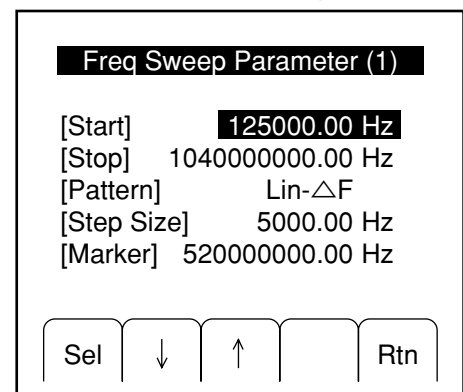

⏟
④

↑
⑦

- (5) Press the [More] key to move on to the "Sweep Parameter (2)" menu. (This menu is not involved in setting parameters for memory sweep.)

- (6) Select the sweep parameter item to be changed, by pressing the "↓" [F2] key or "↑" [F3] key (the characters are highlighted). If the parameter item is a numeric value, operate the number keys and the step keys and rotary knob in the Edit zone to set the value.
To select a status, press the "Sel" [F1].

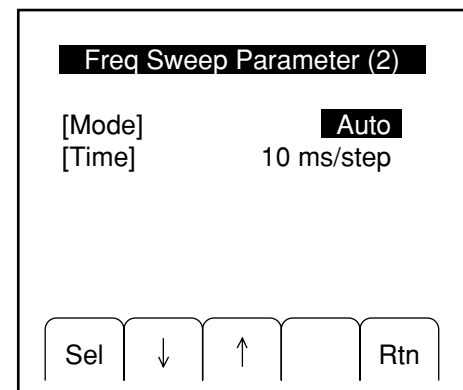

⏟
⑥

↑
⑦

SECTION 4 OPERATING INSTRUCTIONS

Once you have set the sweep parameters, you execute the sweep.

- (7) Press the "Rtn" [F5] key in the "Sweep Parameter" menu to return to the "Sweep" menu.
- (8) Pressing the "▶" [F2] key starts the sweep.

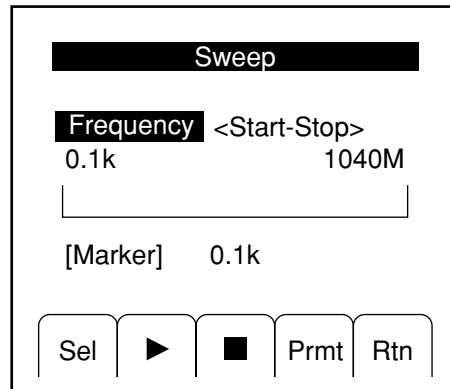

↑
⑧

- (9) Pressing the "■" [F3] key with the sweep under way aborts the sweep. Moreover, pressing "||" key will hold the sweep temporarily. Another press to the [F2] key will resume the sweep.

During hold, the [F2] key is displayed as ||.

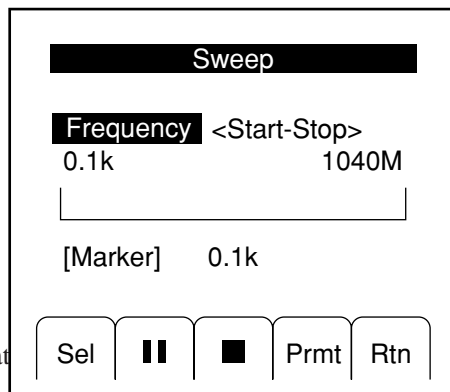

e four

⏟
⑨

4.10.3 Sweep Auxiliary Outputs

While the signal generator performs sweep, it outputs signals that are available at the connectors located on the rear panel, as follows:

- (1) X Out
Outputs sawtooth waves that are at 0 V at the sweep start point, and at +10 V at the sweep end point.
- (2) Z Out
Outputs "H"-level TTL signals while it continues with sweep.
- (3) Blanking Out
Outputs "H"-level TTL signals every sweep step, from the time when hardware setting is completed, till the next step setting begins
- (4) Marker Out
Outputs "H"-level TTL signals when the actual sweep matches the marker point which was set in the "Sweep Parameter" menu.

4.10.3 Sweep Auxiliary Outputs

While the signal generator performs sweep, it outputs signals that are synchronized to the sweep through the four connectors located on the rear panel, as follows:

- (1) X Out
Outputs sawtooth waves that are at 0 V at the sweep start point, and at +10 V at the sweep end point.
- (2) Z Out
Outputs "H"-level TTL signals while it continues with sweep.
- (3) Blanking Out
Outputs "H"-level TTL signals every sweep step, from the time when hardware setting is completed, till the next step setting begins
- (4) Marker Out
Outputs "H"-level TTL signals when the actual sweep matches the marker point which was set in the "Sweep Parameter" menu.

MG3641A/MG3642A rear panel

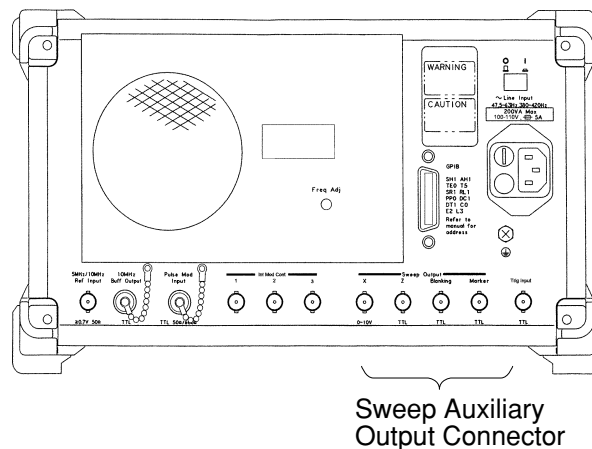

SECTION 4 OPERATING INSTRUCTIONS

The diagram below represents the timing of each sweep auxiliary output.

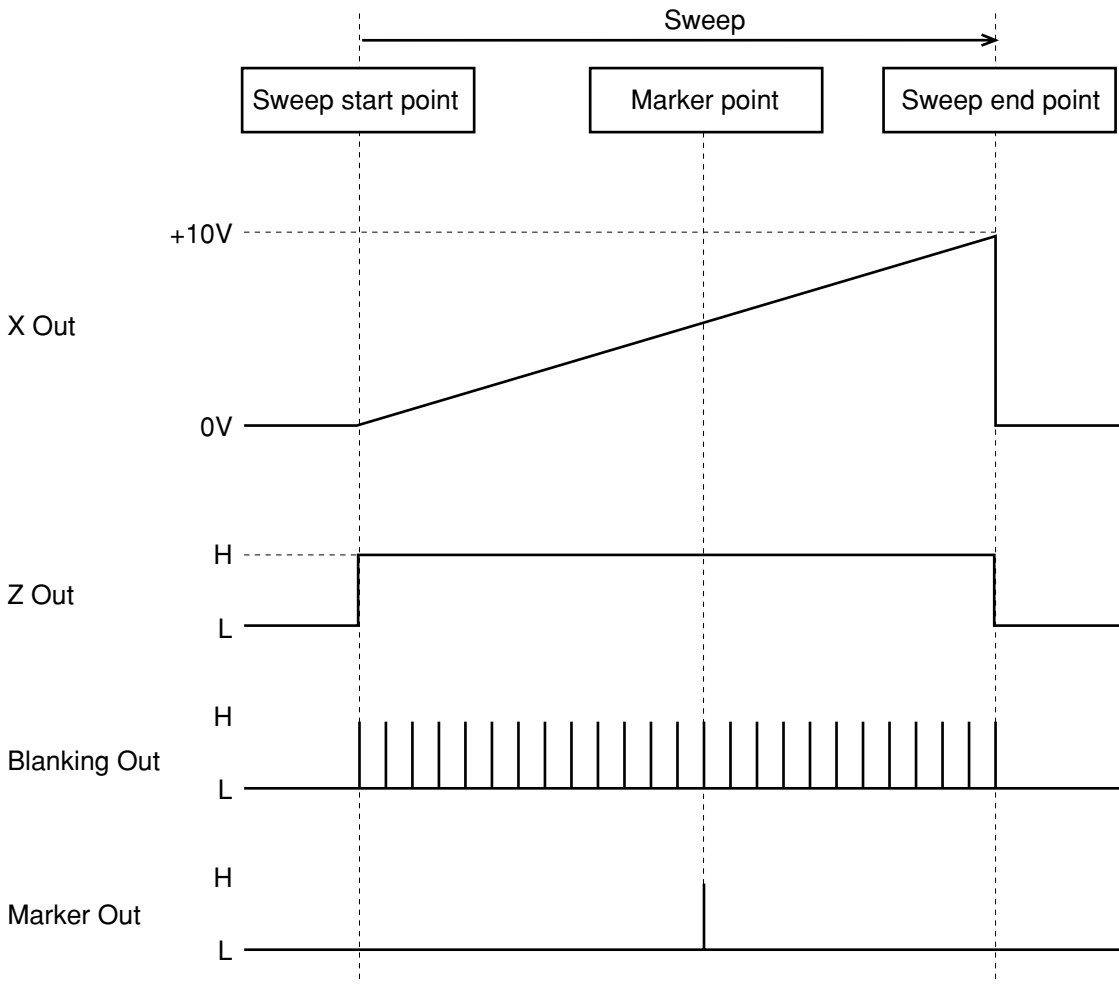

4.11 Trigger Function

4.11.1 Outline of trigger function

The trigger function executes the panel key operation procedures registered beforehand as the trigger program by the external trigger signal. The same measurement procedures can be repeated easily from the operator panel or external device by registering the procedures as the trigger program.

For example, if the Step [^] key of the Output Level zone is registered in the trigger program, the output level can be stepped up each time the trigger is input.

All keys except for the [Preset] key, [Local] key, rotary knobs, and [Stby/On] key can be registered in the trigger program.

To execute the trigger program, generate the trigger signal as follows:

- Input a negative logical pulse from the Trig Input connector on the rear panel.
- Use GPIB to send the *TRG command or execute the trigger interrupt function.
- Press the "Exe" [F4] key of the "Trig Program" menu.

4.11.2 Registering the trigger program

Register the trigger program as follows:

- (1) Press the "Trig" [F5] key on the Main Menu (2) to open the "Trigger Program" menu.

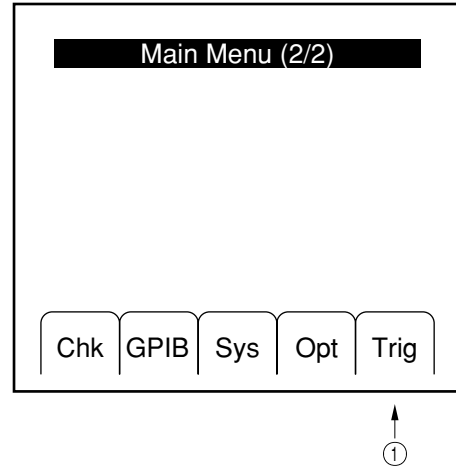

- (2) Press the "Enter" [F3] key. The screen switches to the Main Menu (1) and the device enters the trigger program registration state. Subsequent key operations are registered as the trigger program (the message "Trigger Program Entry" is displayed to indicate that a key operation is being registered).

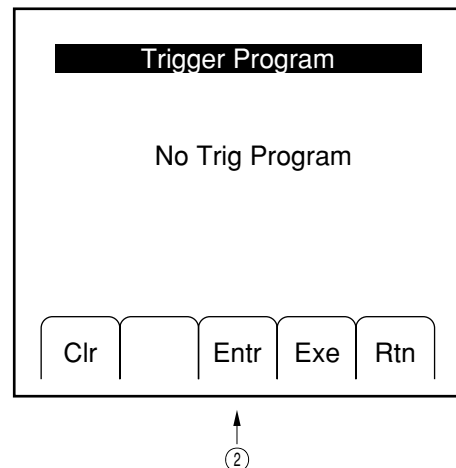

- (3) To terminate registering the trigger program, press the "Trig" [F5] key on the Main Menu (2) again to open the "Trigger Program" menu. Registering the trigger program terminates when the "Trigger Program" menu is opened.

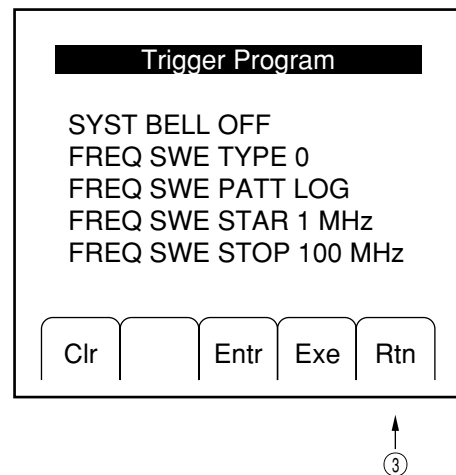

If the trigger program is registered when another trigger program is already registered, the new trigger program is added to the already-registered trigger program. To register a new trigger program, press the "Clr" [F1] key to erase the already-registered trigger program before using the "Entr" [F3] key to enter the registration state in Item (2) above.

When a key is operated while the trigger program is being registered, the function is set as a usual panel operation, but sweep is not executed. The maximum number of trigger program steps (functions) is 20. A trigger program of more than 20 steps cannot be registered. If the number of steps exceeds 20, the message "Trigger entry overflow" is displayed. In this case, open the "Trigger Program" menu and terminate registering the trigger program. Even if the number of steps exceeds 20, the registration state is not canceled automatically.

If no key is operated for 30 seconds or longer while the trigger program is being registered, the registration state is canceled automatically. In this case, the trigger program is not registered.

The sweep mode in which sweep is executed in the trigger program is forcibly set to SINGLE sweep.

4.11.3 Executing the trigger program

Execute the trigger program in one of the following ways:

(1) Execution by the external logic signal

Execute the trigger program at the falling edge of the TTL level signal input from the Trig Input connector on the rear panel. Because this connector is pulled up internally, the trigger program can be executed by simply connecting the connector to the ground.

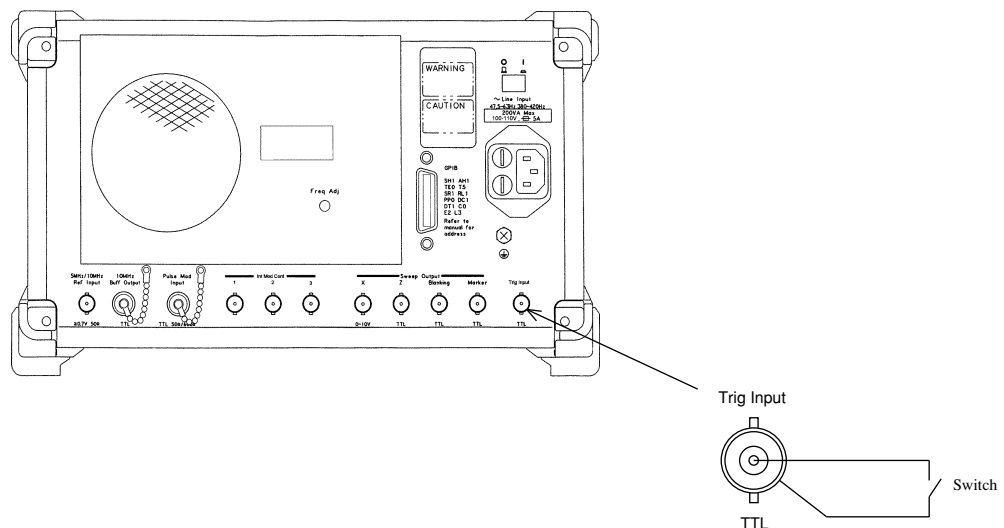

(2) Execution using GPIB

The trigger program can be executed by sending the *TRG command or executing the trigger interrupt function from GPIB.

For GPIB, see Section 6, "Remote control using GPIB."

SECTION 4 OPERATING INSTRUCTIONS

(3) Execution using the panel key

When the "Exe" [F4] key on the "Trigger Program" key is pressed, the trigger program is executed. This method can be used to check the trigger function.

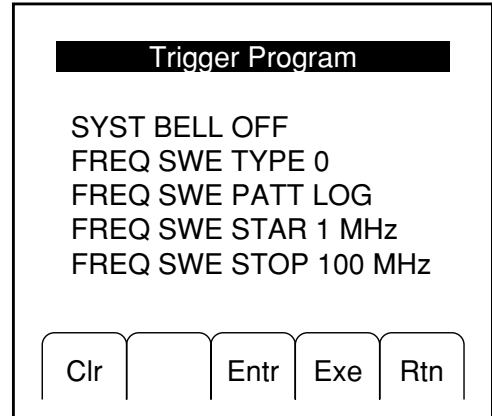

↑
Executing the trigger program

The trigger program can be halted by pressing a key other than the [Preset] or [Local] key on the panel.

4.11.4 Checking the contents of the trigger program

The contents of the trigger program can be checked by opening the "Trigger Program" menu. In the trigger program, one step is displayed as one line. If the trigger program consists of more than one page, a page number is displayed in the menu title. In this case, press the [More] key to advance to the next page.

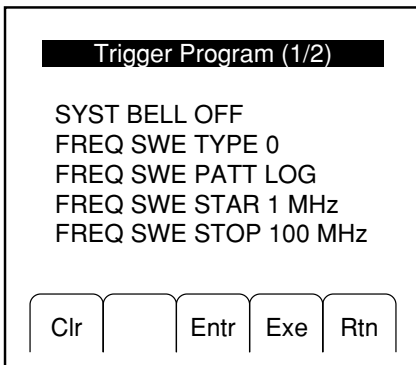

→ [More] キー →

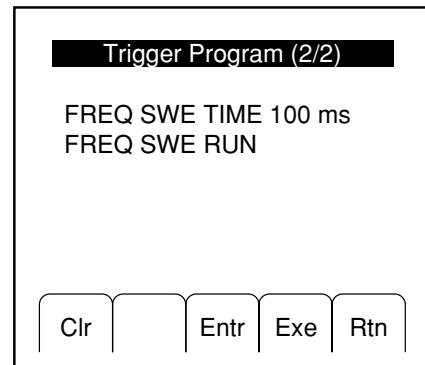

4.12 Miscellaneous Functions

4.12.1 Setting Display On/Off

The MG3641A/MG3642A has a low EMI radiation from the panel, and it does not become a problem at a ordinary measurement.

However, if the radiation affects the measurement, it can be eliminated by pressing the [Display] key to turn off the multi-menu display.

To turn off all the frequency, output level etc. displays, press the [Shift] and then [Display] keys.

To turn on the display again, perform the same key operation.

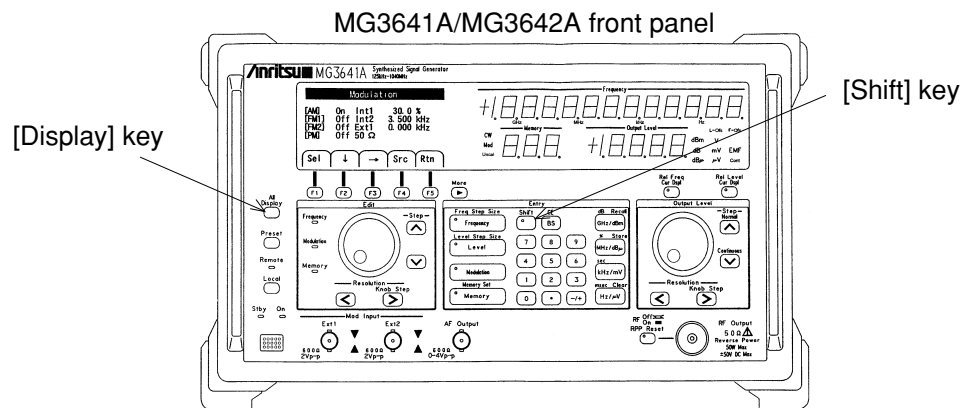

4.12.2 Setting Bell • Alarm On/Off

Bell (bell sound when any panel key is pressed, or the rotary knob is revolved.) • alarm (alarm sound when any error is occurred.) On/Off can be set as follows.

- (1) Press the "Sys" [F3] key on the top menu to open the "System (1)" menu.

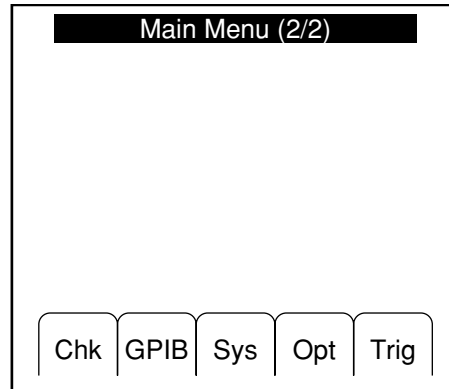

- (2) Press the "↓" [F2] key or "↑" [F3] key, to select "Bell" or "Alarm".
(State is reverse-displayed.)
- (3) Press the "Sel" [F1] key to select On or Off.

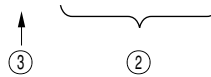
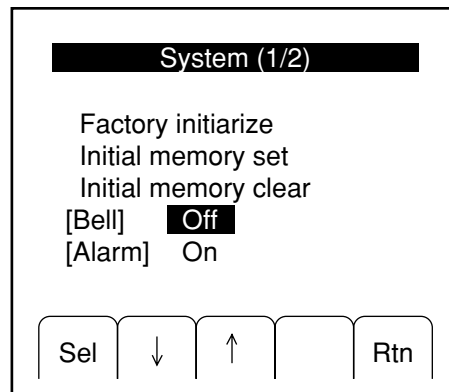

4.12.3 Setting address and only mode of GPIB

The MG3641A/MG3642A has the GPIB only mode.

The GPIB address and only mode are set on the GPIB menu, as described below.

- (1) Press the “GPIB” [F2] key on the top menu to open the “GPIB” menu.

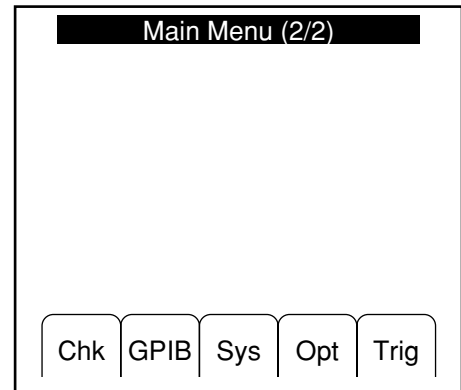

- (2) Press the “↓” [F2] key or “↑” [F3] key to select “Address”.

(Address is reverse displayed.)

Set the address with numeric keys, and confirm the value with any unit key.

- (3) Press the “↓” [F2] key or “↑” [F3] key to select “Mode”.

(State is reverse displayed.)

Press the “Sel” [F1] key to select mode, below.

- Ordinary mode: Talker&Listener
- Talk-only mode of frequency: Freq Talk
- Talk-only mode of level: Level Talk
- Talk-only mode of
frequency and level: Both Talk

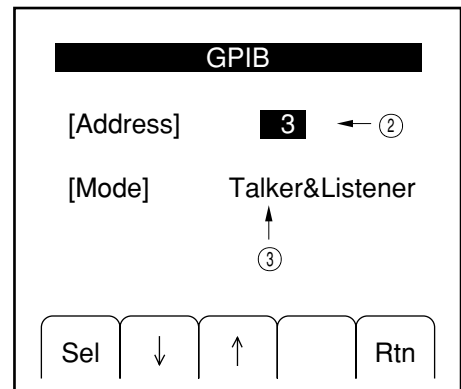

4.12.4 Panel Lock

Not to change the setting condition of this instrument at long-time continuous test etc., press the [Local] key while pressing the [Shift] key to lock all the keys and the rotary knob.

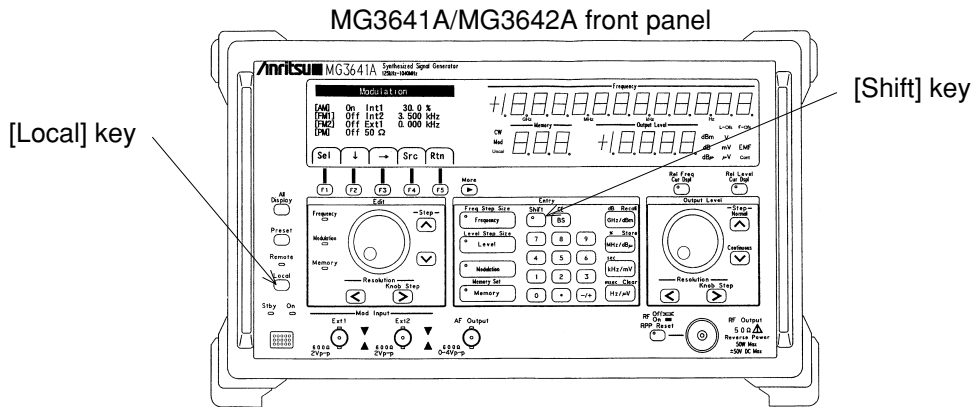

To remove the panel-lock condition, turn off and on the power to recover the ordinary state.

CAUTION

In panel lock mode, the GPIB and trigger functions do not work.

If the panel lock is performed during sweeping operation, the sweeping is stopped.

4.13 Removing Reverse Power Protection (RPP) Circuit Operation

The MG3641A/MG3642A has a Reverse Power Protection (RPP) circuit at the RF Output circuit to protect the internal circuit from the excessive reverse power.

When the RPP circuit operated, “RPP” is displayed at the Output Level display area, and the RF output signal is turned off.

At that time, remove the excessive external power, and press the [Shift] and [RF Off/On] (RPP Reset) keys to remove the RPP operation.

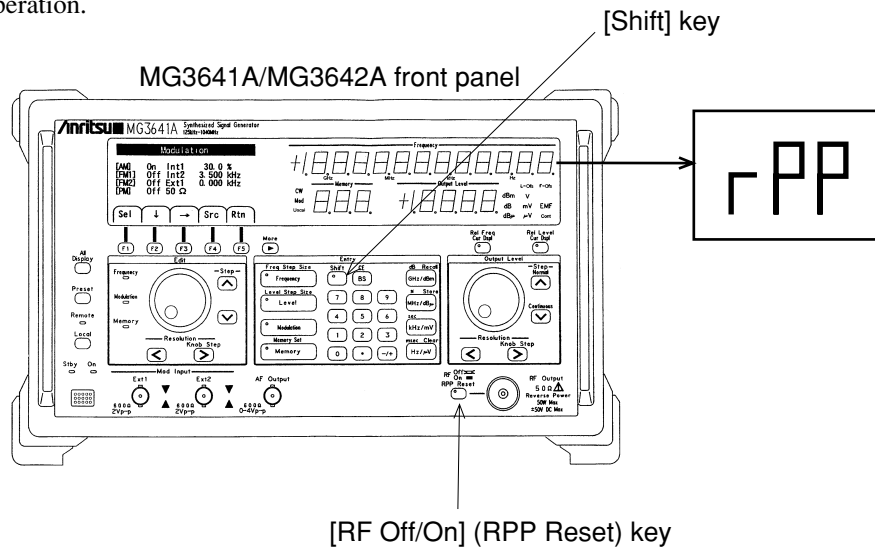

CAUTION

- The RPP circuit uses a mechanical switch. If many times of the operations are occurred, the switch contact is consumed. So, don't apply the excessive power to the RF Output connector, as possible.
- Don't remove the RPP circuit while applying an excessive power. Or the RPP circuit is damaged.
- Maximum reverse power from which the MG3641A/MG3642A can be protected, is 50 Vdc, 50 W (up to 1040 MHz) or 25 W (1040 to 2080 MHz).
- While the RPP circuit operated, the output impedance becomes the open state. So, take care of the connected device under test.

4.14 Error Messages

If a panel operation or device internal error occurs, the MG3641A/MG3642A displays messages in the error message area on the multimenu display.

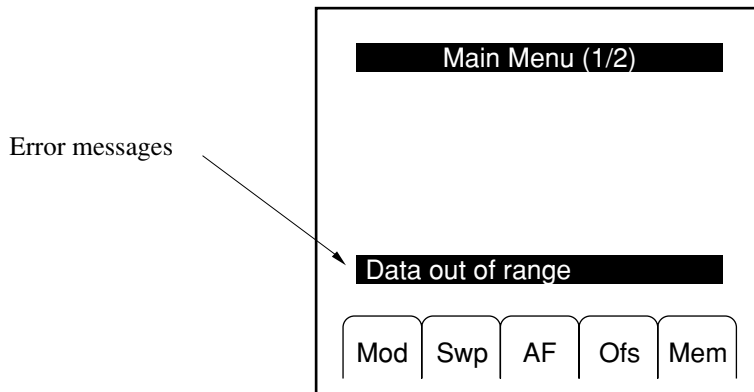

Error messages are given below:

Operation error: Displayed when a setting becomes invalid because of an incorrect operation.

- | | |
|-------------------------|--|
| Data out of range: | An attempt is made to set a value out of range
(e.g., to set the frequency to 10 GHz). |
| Invalid suffix: | A unit key not appropriate for a set parameter is pressed
(e.g., an attempt is made to set the sweep time to 1 MHz) |
| Execution error: | An attempt is made to execute one of the following incorrect operations: <ul style="list-style-type: none"> • To start executing the sweep with an incorrect sweep parameter specified. • To display too many digits on the display unit for the output level offset in volts. • To exceed the upper limit of the variance range (± 10 dB) in level continuous mode. |
| Not Stored memory: | An attempt is made to recall a memory not stored. |
| Trigger entry overflow: | An attempt is made to register a trigger program of more than 20 steps. |
| Trigger entry ignored: | An attempt is made to register the trigger program when sweep is being executed or suspended. |
| Hardware error: | An attempt is made to execute settings relating to an unmounted option
(e.g., to turn on pulse modulation when the pulse modulator is not mounted.) |

Hardware status: Displayed when the MG3641A/3642A is used incorrectly or fault occurs.

RF out shut-down by RPP: The reverse power protection circuit operates.

→ Eliminate the cause and cancel the operation of the reverse power protection circuit (see paragraph 4.13).

Reference signal abnormal: The reference signal is abnormal.

→ The frequency or level of the signal input as an external reference signal is inappropriate. Input a suitable reference signal.

Synthesizer unlock: The synthesizer is unlocked.

→ If this message does not go off after warming up, a failure may occur in the circuit. Request the synthesizer be repaired.

RF Amplifier abnormal: An output level is abnormal.

→ This message is displayed when a setting exceeds the limit of the output amplifier of the final step. In this state, the level identical to the display is not output. If this message is displayed within the level accuracy guarantee range (+17 dBm or less), a fault may have developed. Request the output amplifier be repaired.

When the output amplifier is normal, but the output connector is not impedance-matched, severely (for example, open or short state); this message may be displayed.

Setting outside performance guarantee range: This message is displayed if a value is set outside the performance guarantee range.

Level uncal: A value is set outside the output level accuracy guarantee range.

→ Even if this message is displayed, the output level is usually accurate provided that the message "RF Amplifier Abnormal" is not displayed.

FM uncal: FM deviation is set outside the setting range.

→ The setting range of the FM deviation depends on the carrier frequency. If the FM deviation setting range at the current carrier frequency is exceeded, this message is displayed and the FM deviation becomes that of the upper limit of the setting range.

AM uncal: The AM modulation is set outside the guarantee range.

→ This message is displayed if the AM modulation is set outside the performance guarantee range.

Except for the above cases, various types of errors during remote control using GPIB are also displayed. For error messages relating to GPIB, see paragraph 6.5.5, "SCPI error messages."

SECTION 4 OPERATING INSTRUCTIONS

(Blank)

SECTION 5

MEASUREMENT

5.1 Measurement of Sensitivity

The sensitivity of the receiver means the minimum signal input level required to output the rated signal of the receiver. The following incidental conditions are required for the signal level, noise level, and signal distortion obtained in the output side of the receiver:

- AM receiver Indicated by the minimum value of the typically modulated carrier voltage required to output the rated signal of the specified signal-noise rate (S/N). For example, when $S/N = 20$ dB, the minimum value of the carrier input voltage for 60 % modulation required to output the 50-mW signal is indicated by $10 \mu\text{V}$.
- FM receiver Indicated by the minimum value of the typically modulated carrier voltage required to obtain the rated output and specified value (-12 dB in 400 MHz) of the signal to noise and distortion (SINAD) obtained by adding the signal distortion to the signal-noise rate (S/N). In addition, this sensitivity is indicated by the minimum value of the carrier voltage required to suppress the receiver noise output by 20 dB at no-modulation. This is called a noise suppression (NQ) sensitivity.

This section describes the latter 20 dB NQ sensitivity and explains how to measure the 12 dB SINAD sensitivity.

SECTION 5 MEASUREMENT

5.1.1 Measuring 20 dB NQ sensitivity

The 20 dB NQ sensitivity is indicated the carrier input voltage (reading value of the output voltage of the signal generator) required to suppress the noise output by 20 dB when there is no 20 dB noise quieting, e.g., signal input. To obtain the noise output before suppressed, adjust the volume adjustment volume of the receiver so that the rated signal output is obtained.

(1) Setup

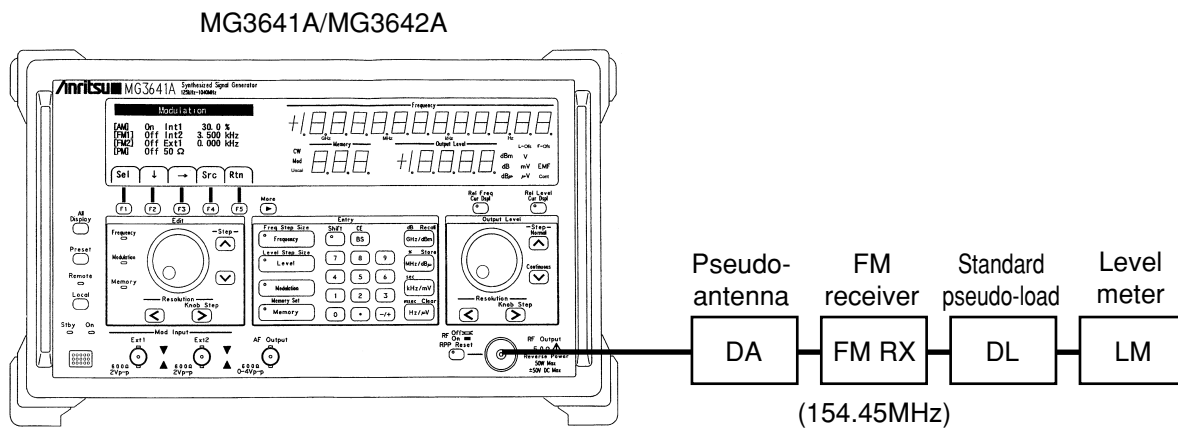

Fig. 5-1. Measuring 20 dB NQ Sensitivity

(2) Measurement procedure

STEP	PROCEDURE
1.	Set the MG3641A/MG3642A frequency to 154.45 MHz.
2.	Set the MG3641A/MG3642A frequency deviation to 70 % (3.5 kHz for maximum frequency deviation 5 kHz) of the specified maximum frequency deviation. Then, set the internal modulation frequency to 1 kHz.
3.	Set the MG3641A/MG3642A to a sufficiently high output (ordinarily 30 dB μ or more) and apply it to the receiver.
4.	Turn off the squelch of the receiver, synchronize the receiver with receiving frequency 154.45 MHz (so that the reading value of the level meter is the maximum), then adjust the volume adjust volume of the receiver so that the rated output of the receiver is obtained according to the indicator of the level meter.
5.	Turn off the MG3641A/MG3642A output.
6.	Use the level meter to measure the receiver noise output and set the meter indicator to 0 dB.
7.	Turn off the MG3641A/MG3642A modulation and turn on the MG3641A/MG3642A output.
8.	Adjust the MG3641A/MG3642A output level so that the indicator of the level meter is set to -20 dB.
9.	The reading value of the MG3641A/MG3642A output level indicator is a 20 dB NQ sensitivity in step 8.

5.1.2 Measuring 12 dB SINAD sensitivity

The SINAD sensitivity is indicated by the output level of the signal generator when the distortion rate reaches the determined value (−12 dB in the 400 MHz zone of Japan) by reducing the output level of the signal generator while measuring the distortion (correctly distortion + noise) of the receiving modulation output of the typically modulated signal.

(1) Setup

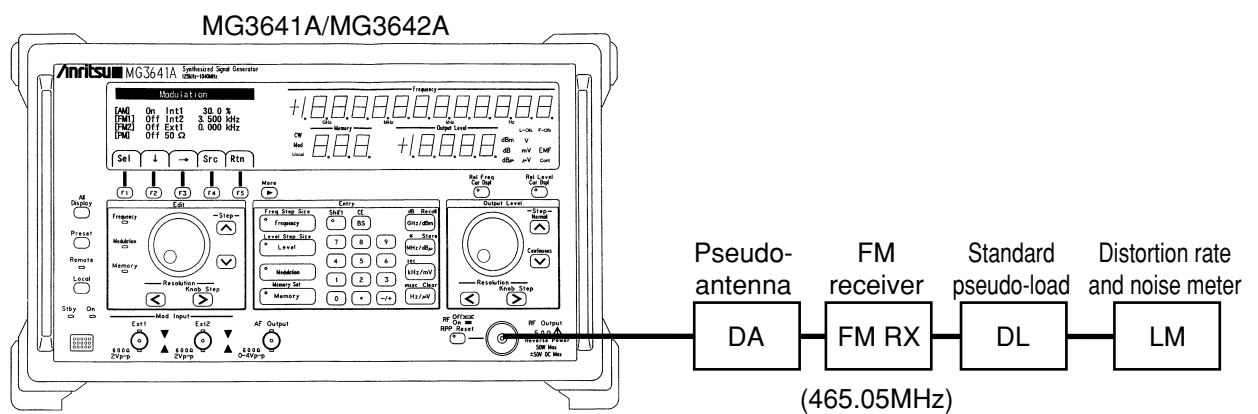

Fig. 5-2. Measuring 12 dB SINAD Sensitivity

(2) Measurement procedure

STEP	PROCEDURE
1.	Set the MG3641A/MG3642A frequency to 465.05 MHz.
2.	Set the MG3641A/MG3642A frequency deviation to 70 % (3.5 kHz for maximum frequency deviation 5 kHz) of the specified maximum frequency deviation. Then, set the internal modulation frequency to 1 kHz.
3.	Set the MG3641A/MG3642A to a sufficiently high output (ordinarily 30 dB μ or more) and apply it to the receiver.
4.	Turn off the squelch of the receiver, synchronize the receiver with receiving frequency 465.05 MHz (so that the reading value of the distortion rate and noise meter is the maximum), then adjust the volume adjust volume of the receiver so that the rated output of the receiver is obtained according to the indicator of the distortion rate and noise meter.
5.	Adjust the MG3641A/MG3642A output level so that the indicator of the distortion rate and noise meter is set to −12 dB.
6.	The reading value of the MG3641A/MG3642A output level indicator is a 12 dB SINAD sensitivity in step 5.

5.2 Measuring the 1-signal Selectivity

The 1-signal selectivity is measured when the receiver operates in a proportional region because the expected wave and interference disturbing wave are fine. It is indicated by the relative input voltage rate required to equalize the output of the receiver by connecting the signal generator to the receiver input pin in the expected wave receiving state and changing its frequency to the expected or disturbing one. This method is available to measure a pass band width, attenuation slope, and spurious response.

5.2.1 Measuring selectivity characteristics of the FM receiver in 20 dB NQ method

This figure shows the selectivity characteristics of a signal-channel FM receiver 146 to 162 MHz. The approved values are as follows:

- Pass band width 6 dB (Reduction width = 20 kHz or more)
- Attenuation slope 70 dB (Reduction band width = 50 kHz or less)

These conditions apply to measure the selectivity in the 20 dB NQ method as follows:

- Pass band width Increase the SG output by 6 dB as compared with the NQ sensitivity and move up or down the frequency so that the NQ sensitivity is obtained again. Then, obtain this width from its frequency width.
- Attenuation factor Increase the SG output by 60 dB, not 6 dB like the above.

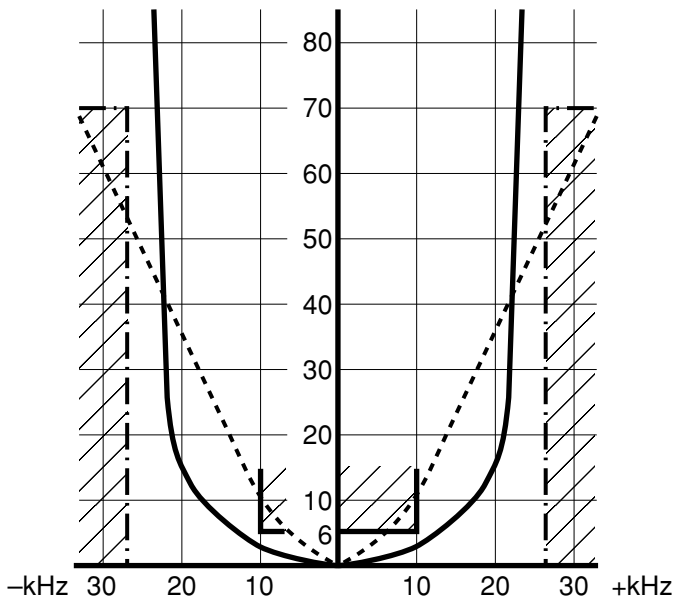

- The characteristics curve must not be in the hatched part. The solid line is approved; the broken line is rejected.

(1) Setup

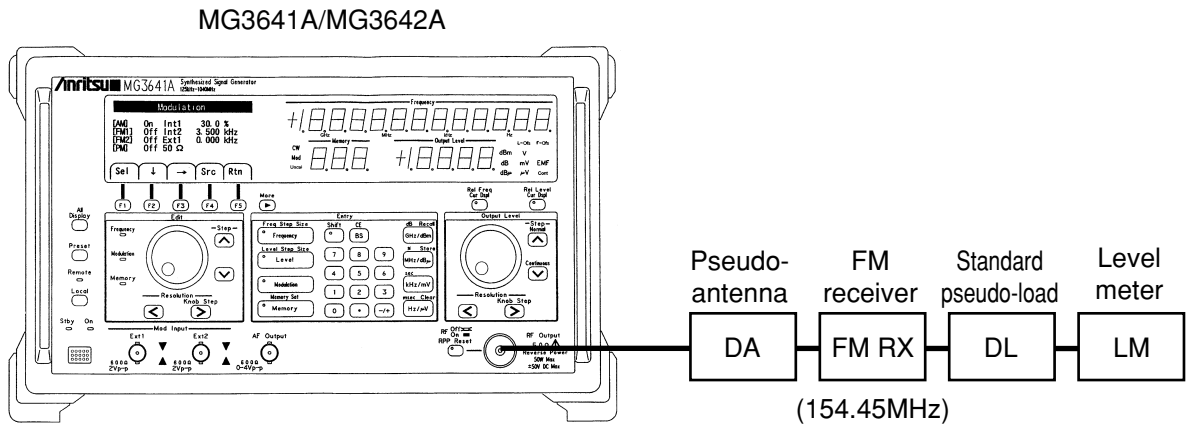

Fig. 5-3. Measuring Selectivity in 20 dB NQ Method

(2) Measurement procedure (Pass band width)

STEP	PROCEDURE
1.	Set the MG3641A/MG3642A frequency, output level, and FM receiver setting into the 20 dB NQ sensitivity mode.
2.	Place the MG3641A/MG3642A into the relative level display mode and set the output level resolution to 1 dB.
3.	Clockwise turn the rotary knob of Output to increase the MG3641A/MG3642A output level by 6 dB as compared with the 20 dB NQ sensitivity (set the display of the output level indicator to +6 dB).
4.	Set the MG3641A/MG3642A frequency resolution to 100 Hz.
5.	Clockwise turn the rotary knob of Edit to reduce the frequency and adjust it until the 20 dB NQ sensitivity is obtained again.
6.	Place the MG3641A/MG3642A into the relative frequency display mode.
7.	Clockwise turn the rotary knob of Edit to increase the frequency and adjust it until the 20 dB NQ sensitivity is obtained again.
8.	The value indicated by the Frequency indicator is the pass band width.

SECTION 5 MEASUREMENT

(3) Measurement procedure (Attenuation rate)

STEP	PROCEDURE
1.	Set the MG3641A/MG3642A frequency, output level, and FM receiver setting into the 20 dB NQ sensitivity mode.
2.	Place the MG3641A/MG3642A into the relative level display mode and set the output level resolution to 1 dB.
3.	Clockwise turn the rotary knob of Output to increase the MG3641A/MG3642A output level by 70 dB as compared with the 20 dB NQ sensitivity (set the display of the output level indicator to +70 dB).
4.	Set the MG3641A/MG3642A frequency resolution to 100 Hz.
5.	Clockwise turn the rotary knob of Edit to reduce the frequency and adjust it until the 20 dB NQ sensitivity is obtained again.
6.	Place the MG3641A/MG3642A into the relative frequency display mode.
7.	Clockwise turn the rotary knob of Edit to increase the frequency and adjust it until the 20 dB NQ sensitivity is obtained again.
8.	The value indicated by the Frequency indicator is the pass band width that reduced by 70 dB.

5.2.2 Measuring spurious response

The spurious sensitivity reduces as the receiver output obtained at reception of the modulated desired-frequency is different from that obtained at reception of the modulated spurious frequency. To measure the spurious response, adjust the output level of the signal generator of the spurious frequency so that these two receiver outputs are equal. Then, obtain that value from the difference between the output level of the signal generator of the desired frequency and that of the signal generator of the spurious frequency.

When the desired frequency of the receiver is f_d ; IF frequency is f_i ; local frequency is f_L , the following frequency is assumed to be spurious frequency f_s .

- Image frequency $f_s = f_L \pm f_i = f_d \pm 2f_i$
- Higher harmonic $f_s = f_L \pm f_i/2$, $f_s = n f_d \pm f_i/2$
If a frequency that sets the difference from the local frequency to $f_i/2$ is input, the second higher harmonic of $f_i/2$ changes to an IF frequency and an interference occurs.
- Harmonic frequency of local frequency $f_s = n f_L \pm f_i$

This section shows an example of $f_d = 154.45$ MHz, $f_s = f_d + 2 f_i$. $f_i = 10.7$ MHz to explain the measurement procedure.

(1) Setup

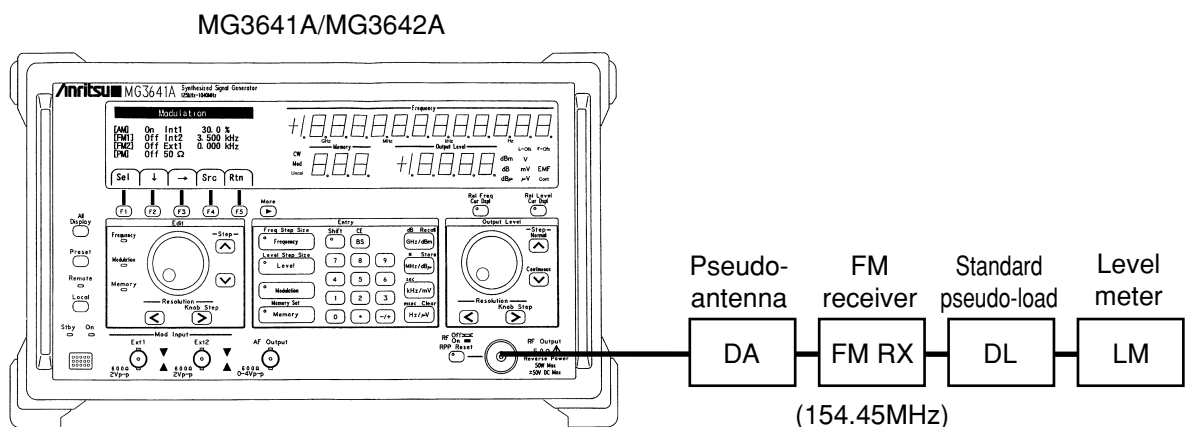

Fig. 5-4. Measuring Spurious Sensitivity

SECTION 5 MEASUREMENT

(2) Measurement procedure

STEP	PROCEDURE
1.	Set the MG3641A/MG3642A frequency to $f_d = 154.45$ MHz.
2.	Set the MG3641A/MG3642A frequency deviation to 70 % of the specified maximum frequency deviation (3.5 kHz if the maximum frequency deviation is 5 kHz). Then, set the internal modulation frequency to 1 kHz.
3.	Set the MG3641A/MG3642A to a sufficiently high output (ordinarily 30 dB μ or more) and apply it to the receiver.
4.	Turn off the squelch of the receiver, modulate the receiver to receiving frequency 154.45 MHz (maximize the value of the level meter), adjust the volume adjustment volume of the receiver, and obtain the rated output of the receiver from the indicator of the level meter.
5.	Place the MG3641A/MG3642A into the relative frequency display mode.
6.	While holding the receiver state, MG3641A/MG3642A modulation frequency, and frequency deviation to the same, apply the spurious frequency of the receiver, $f_s = f_d + 2 f_i$, to the receiver. The spurious frequency is obtained by adding $2 \times f_i = 2 \times 10.7$ MHz in the relative frequency mode.
7.	Place the MG3641A/MG3642A into the relative level mode and set the output level resolution to 1 dB.
8.	Adjust the MG3641A/MG3642A output level so that the value of the level meter becomes the same as the rated output obtained in step 4.
9.	The value indicated by the MG3641A/MG3642A output level indicator in step 8 is a spurious sensitivity.

5.3 Measuring the 2-signal Selectivity

In the conventional method of measuring the selectivity of one signal in the output fixing method, the input signal level had to be changed in a large range from about 0 dBm to about 100 dBm. It is generally difficult to operate each part of the amplifier of the receiver according to such a large change of the level. The amplifier normally operates in the 10 dB change range; however, in the higher range, an error occurs in the measured value because the sensitivity reduces by the saturation, etc.

To measure the sensitivity in the actual reception state, the 2-signal selectivity (also called effective selectivity) is provided. This sensitivity directly indicates the interference resolution of the receiver, that is, it indicates the maximum level of the allowable input of the disturbing wave when suppressing the disturbing output level of the receiver to a fixed value during reception of the desired wave. There are the following three types of 2-signal sensitivities:

- Sensitivity blocking (suppression)
- Cross-modulation
- Inter-modulation

This section explains the sensitivity blocking and cross-modulation.

5.3.1 Measuring the sensitivity blocking of the FM receiver

The desired and disturbing waves are indicated by a disturbing wave input level when the noise suppression is set to 20 dB by applying the desired input voltage (higher by 6 dB than the input voltage of the receiver required to set the noise suppression to 20 dB) and supplying a disturbing wave separate from the desired wave by Δf kHz.

Change the frequency of the disturbing wave and measure the disturbing wave input level; the characteristics are obtained as shown in this figure.

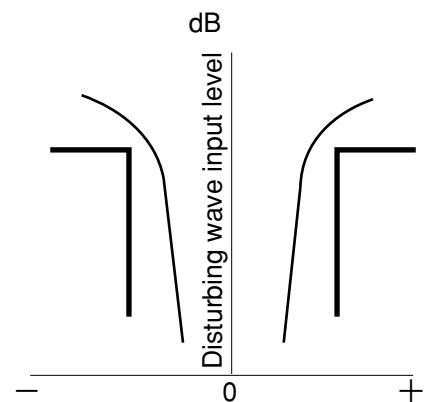

In this paragraph, to explain the measurement procedure, the desired wave is set to 154.45 MHz and the disturbing wave is separated from it by $\pm 20 \text{ kHz} \times n$.

SECTION 5 MEASUREMENT

(1) Setup

MG3641A/MG3642A ① (For desired wave)

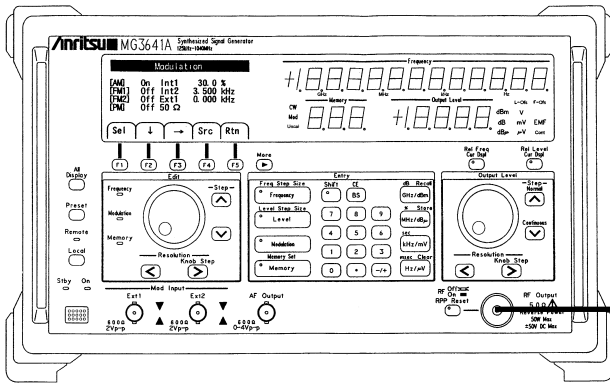

MG3641A/MG3642A ② (For desired wave)

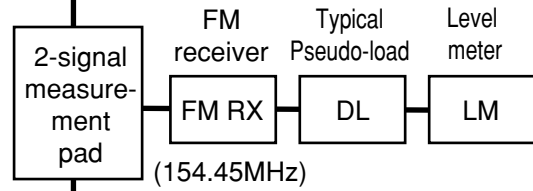
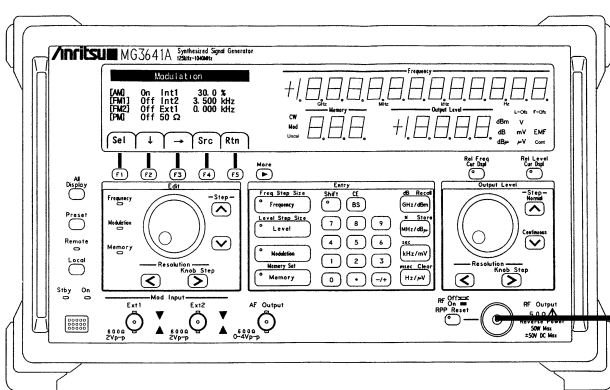
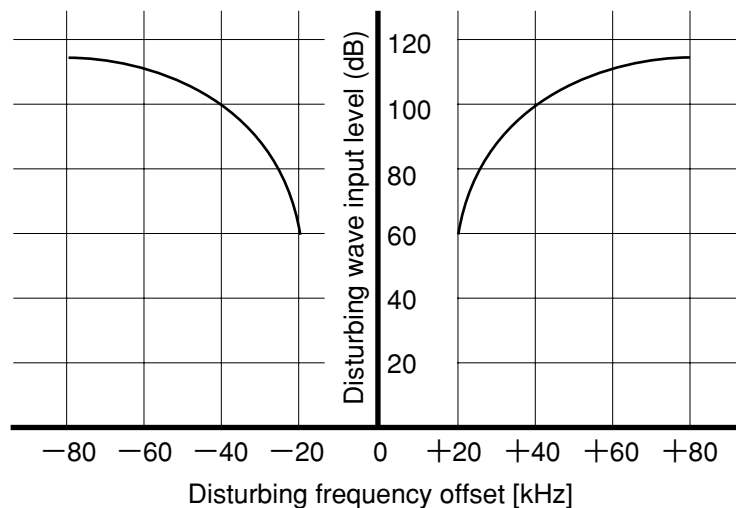

Fig. 5-5. Measuring the 2-signal Selectivity

(2) Measurement procedure

STEP	PROCEDURE
1.	Turn off the output of MG3641A/MG3642A ②.
2.	Place the frequency, output level, and FM receiver setting of MG3641A/MG3642A ① into the 20 dB NQ sensitivity state. In this case, the noise level is V_N dB.
3.	Turn off the output of MG3641A/MG3642A ① and place the frequency and output level of MG3641A/MG3642A ② into the 20 dB NQ sensitivity state.
4.	Turn off the output of MG3641A/MG3642A ② again and turn on the output of MG3641A/MG3642A ①.
5.	Place MG3641A/MG3642A ① into the relative display level mode and set the output level resolution to 1 dB.
6.	Clockwise turn the rotary knob on the right of MG3641A/MG3642A ① to increase the output level of MG3641A/MG3642A ① by 6 dB as compared with the 2 dB NQ sensitivity (set the display of the output level indicator to +6 dB).

STEP	PROCEDURE
7.	Turn on the output of MG3641A/MG3642A ②, place MG3641A/MG3642A ② into the relative level mode, and set the output level resolution to 1 dB.
8.	Set the frequency step size of MG3641A/MG3642A ② to 20 kHz.
9.	Turn the rotary knob to adjust the output level so that the noise output of the receiver is set to V_N dB obtained in step 2 each time the Edit [^] key of MG3641A/MG3642A ② is pressed. The value indicated by the output level indicator is the disturbing input level separated from the desired wave by $+\Delta f \times n$.
10.	Return the frequency and output level of MG3641A/MG3642A ② in the state set in step 3 (frequency and output level indicators set to +0).
11.	Turn the rotary knob to adjust the output level so that the noise output of the receiver is set to V_N dB obtained in step 2 each time the Edit [v] key of MG3641A/MG3642A ② is pressed. The value indicated by the output level indicator is the disturbing input level separated from the desired wave by $-\Delta f \times n$.
12.	The following sensitivity suppression characteristics are obtained in steps 9 and 11:



5.3.2 Measuring the cross-modulation characteristics

The cross-modulation characteristics are indicated by the input level of a disturbing level when the receiver output obtained at detection of a disturbing modulation wave adjacent to an unmodulated expected-signal is lower than the output obtained at detection only of the modulated desired-signal by a specific value, e.g., 20 dB.

NOTE

The cross-modulation occurs in the receiver as the desired signal modulated by the modulation signal of the disturbing signal because the receiver operates non-linearly when the desired receiving signal is applied to the receiver as well as a disturbing wave having a different higher-level modulated frequency.

(1) Setup

The configuration is the same as that of the 2-signal selectivity above. However, this paragraph describes the AM receiver.

To explain the measurement procedure, the desired wave is set to 1500 kHz and the disturbing wave is separated from it by $\pm 5 \text{ kHz} \times n$.

(2) Measurement procedure

STEP	PROCEDURE
1.	Turn off the output of MG3641A/MG3642A ②.
2.	Set the frequency of MG3641A/MG3642A ① to 1500 kHz.
3.	Set the AM modulation of MG3641A/MG3642A ① to 30 % and internal modulation frequency to 400 Hz.
4.	Synchronize the receiver with receiving frequency of 1500 kHz so that the indicator of the level meter reaches the maximum, turn off the AGC of the receiver, then place the receiver into the appropriate state.
5.	Adjust the output level of MG3641A/MG3642A ① so that the indicator of the level meter reaches the rated signal output.
6.	The value indicated by the output level indicator of MG3641A/MG3642A ① in step 5 is $E_1 \text{ dB}\mu$.
7.	Turn off the modulation of MG3641A/MG3642A ① and turn on the output of MG3641A/MG3642A ②.
8.	Set the frequency of MG3641A/MG3642A ② to 1500 kHz.
9.	Set the output level of MG3641A/MG3642A ② to that of MG3641A/MG3642A ①, $E_1 \text{ dB}\mu$ in step 6.
10.	Set the AM modulation and modulation frequency of MG3641A/MG3642A ② to those of MG3641A/MG3642A ① in step 3.
11.	Change the output level of MG3641A/MG3642A ② and set the value of the output level indicator of MG3641A/MG3642A ② to $E_2 \text{ dB}\mu$ when the receiver output is lower than the rated signal output set in step 5 by -20 dB . (This is a cross-modulation characteristic when the disturbing wave is the same as the desired frequency.) Then, set the level of the rated output -20 dB (1/10) to $V_s \text{ dB}$.
12.	Place MG3641A/MG3642A ② into the relative frequency display mode and relative level display mode, then set the output level resolution to 1 dB.
13.	Set the frequency step size of MG3641A/MG3642A ② to 5 kHz.

STEP	PROCEDURE
14.	Turn the rotary knob to adjust the output level so that the noise output of the receiver is set to V_s dB described in step 11 each time the Edit [^] key of MG3641A/MG3642A ② is pressed. The value indicated by the output level indicator is a disturbing wave input level (dB) separated from the desired wave by $+\Delta f \times n$.
15.	Return the frequency and output level of MG3641A/MG3642A ② into the state set in step 12 (frequency and output level indicators set to +0).
16.	Turn the rotary knob to adjust the output level so that the noise output of the receiver is set to V_s dB described in step 12 each time the Edit [v] key of MG3641A/MG3642A ② is pressed. The value indicated by the output level indicator is a disturbing wave input level separated from the desired wave by $-\Delta f \times n$.
17.	The selectivity characteristics are obtained from steps 14 and 16, taking into account the following:

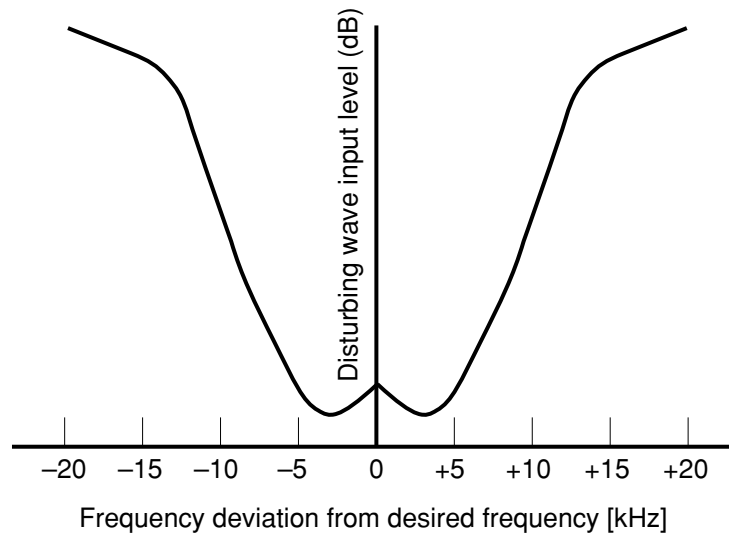

SECTION 5 MEASUREMENT

(Blank)

SECTION 6

GPIB

6.1 Outline of GPIB

6.1.1 Overview

The MG3641A/MG3642A synthesized signal generator can automate the measurement by a combination with an external controller and other instruments.

This device conforms to the institute of electrical and electric engineers (IEEE) std 488.1-1987. The software standard conforms to IEEE488.2 and standard commands for programmable instruments (SCPI).

6.1.2 GPIB functions

This device has the following four GPIB functions:

- Control of all the functions excluding the [Stby/On] switch and [Local] key
- Reading all setting conditions
- Setting a GPIB address from the panel
- Synchronous control of frequency and level in only mode

6.1.3 Setup example

This section shows a setup example using GPIB.

- (1) Control from host computer
Connect the host computer to automatically control this device.

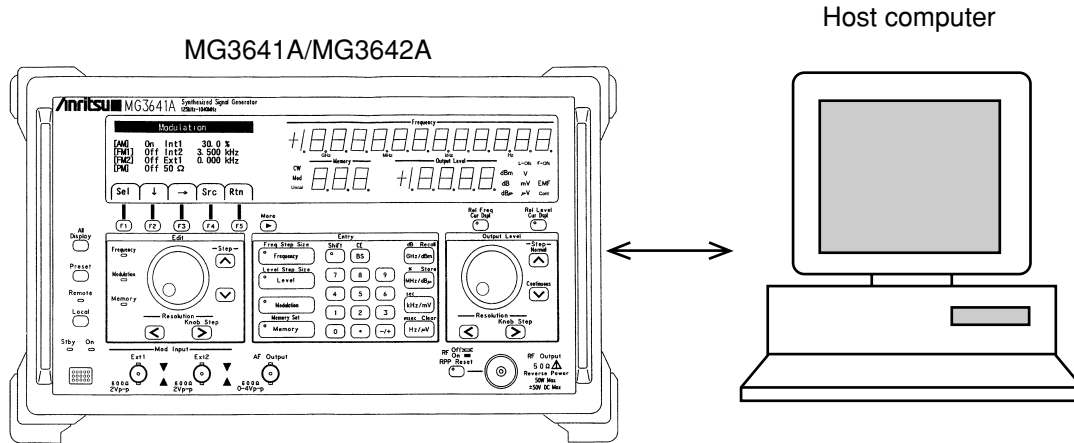

- (2) Synchronous control in only mode
Connect two MG3641A/MG3642A units to synchronously control the frequency or output level.

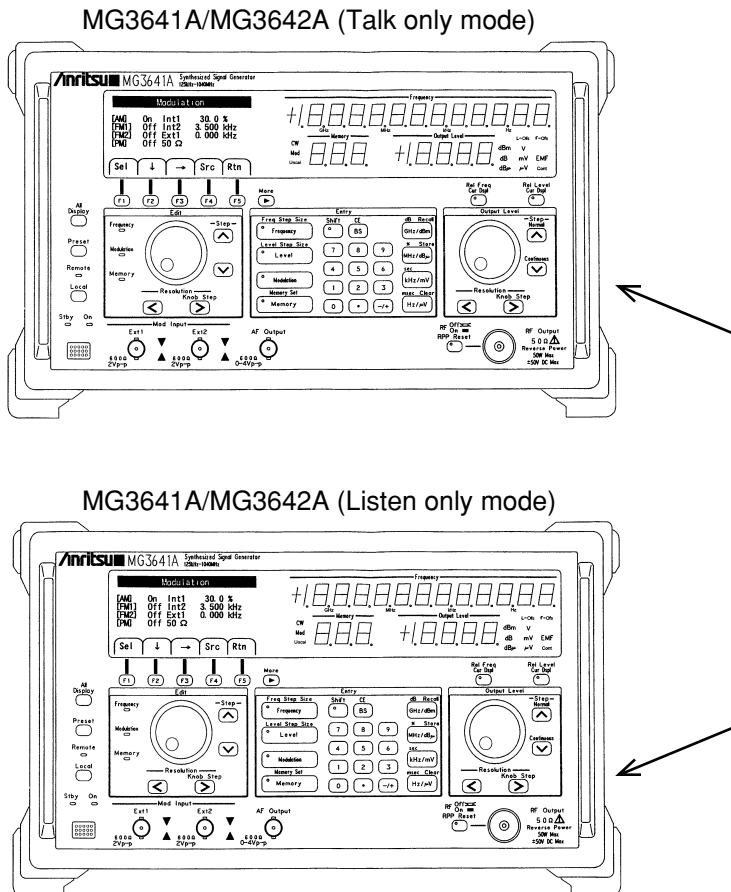

6.1.4 Standard

The MG3641A/MG3642A GPIB is provided with the IEEE488.1 interface function subset listed in the table below.

GPIB Interface Function

Code	Interface function
SH1	Supports all the source handshake functions and takes a data sending timing.
AH1	Supports all the acceptor handshake functions and takes a data receiving time.
T5	Supports the basic talker functions, serial poll functions, talk only mode functions, and talker release function by MLA.
L3	Supports the basic listener functions, listen only functions, and listener release function by MLA.
SR1	Supports all the functions of the service request and status byte.
RL1	Supports all the remote/local functions and local lock-out functions.
PP0	No parallel poll function
DC1	Supports all the device clear functions.
DT1	Supports all the device trigger functions
C0	No system controller function

6.2 Device Message List

6.2.1 Outline

The device messages are data messages transferred between the controller and device through a system interface. They are classified into two types: program and response messages.

The program message is an ASCII data message transferred from the controller to the device. It is divided into two types: program command and program query.

The response message is an ASCII data message transferred from the device to the controller.

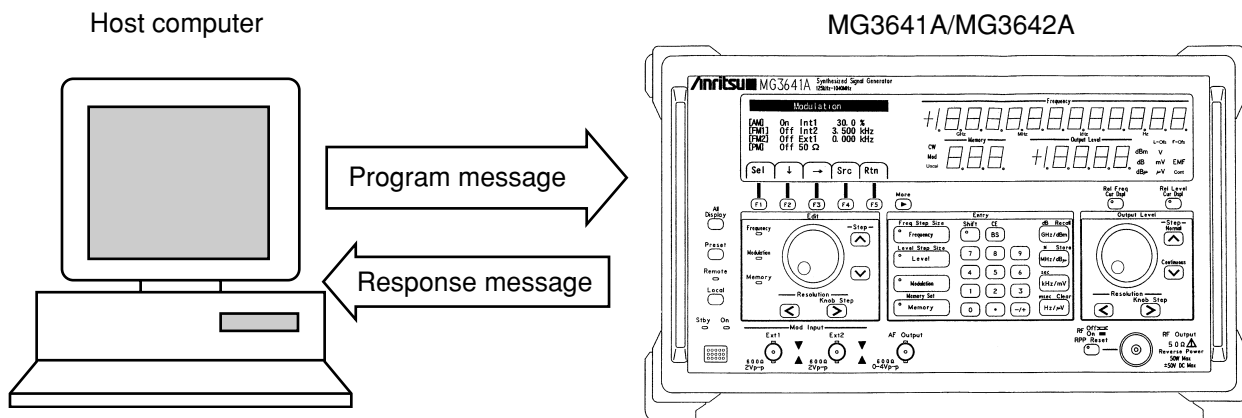

6.2.2 General Information On SCPI

SCPI is an instrument command language that is defined by the SCPI Consortium. It does not depend on the hardware. The goal of SCPI is to reduce the development period for Automatic Tests Equipment (ATE) programs. To accomplish this goal, SCPI provides a consistent programming environment for instrument control and data usage. The features are that the SCPI software is compatible between instruments of the same class, and between different instruments which uses the same commands and parameters to control the instruments that have the same functions.

6.2.3 Command Structure

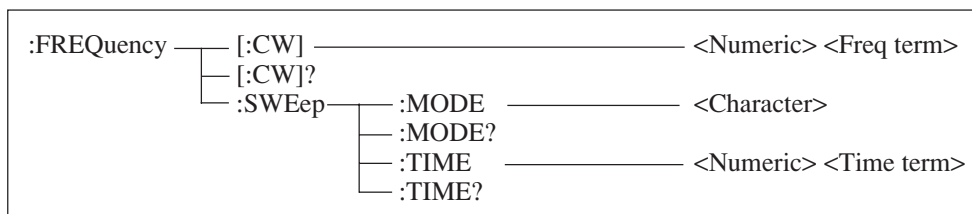

Fig. 6-1. SCPI Command Tree Example

SCPI commands are based on a hierarchical structure. The commands are grouped according to the associated functions. They form hierarchical structures called 'subsystems'.

In this manual, each subsystem is represented by a command tree as shown in the above figure.

Where the same headers appear in a tree, the position of the headers correspond to different functions. This means that commands must be written with the full path including the header to be used.

Examples: FREQUency subsystem

FREQUency denotes the highest level node.

CW, CW? and SWEep denotes the second level node.

MODE, MODE?, TIME and TIME? denote the third level node.

<Numeric> and <Character> are used for CW, MODE and TIME parameter types, respectively.

<Freq term> and <Time term> are used for frequency and time unit types, respectively.

6.2.4 Writing Commands

:FREQUency[:CW]<Numeric> <Freq term>	<Numeric> =0 Hz to 1040 MHz
:FREQUency[:CW]?	
:FREQUency:SWEep:MODE	<Character> =AUTO, SINGLE, MANUAL
:FREQUency:SWEep:MODE?	
:FREQUency:SWEep:TIME<Numeric> <Time term>	<Numeric> =10 μ s to 600 s
:FREQUency:SWEep:TIME?	

Fig. 6-2. Writing Commands

Fig. 6-2 shows how to write the commands in the command tree shown in Fig. 6-1.

The rules of writing commands are explained below.

<Command format>

The first character of an SCPI command is the colon symbol(:).

The command is also configured by concatenating a colon(:) between headers.

<Abbreviated format for header>

A header has both a short form and a long form. A short form header is an abbreviation of a long form header. It is abbreviated to the upper-case characters from the long form header. Whether a short or long command is used, it is interpretable as the same command with the same function. Short forms and long forms can be used together.

The command reference allows both upper-case and lower-case alphabetic characters to be used to differentiate short form keyword from the long form of the same keyword. In fact, there is no differentiation between upper-case

and lower-case.

(The three types of headers, FREQUENCY, Frequency, and frequency are all interpretable as the same header.)

Example: Long form → :FREQuency:SWEep:MODE AUTO
 Short form → :FREQ:SWE:MODE AUTO
 Long + Short → :FREQ:SWEep:MODE AUTO

<Option node>

The symbol [] indicates an option node. The header enclosed within the [] may abbreviated. It is accepted as a command whether abridged or unabridged.

Example: When a header is abridged → :FREQuency:CW 10 MHz
 When a header is unabridged → :FREQuency 10 MHz

<Command separator>

One or more spaces must be placed between a command and a parameter. Two or more parameters must be separated with a comma (,).

6.2.5 Compounding Commands

Commands can be chained with a semicolon (;) as shown in the following examples. The second command is referred to the same level as the lowest layer of the first command. This allows the second command to be written with the full path name, as shown in the example 1. However, as shown in example 2, the header with a higher order than SWEep can be omitted.

Example: 1 → :FREQuency:SWEep:MODE AUTO;:FREQuency:SWEep:TIME 50 ms
 2 → :FREQuency:SWEep:MODE AUTO;TIME 50 ms

6.2.6 Parameter

The table below shows the parameter types employed for this instrument.

In this manual, these parameter types are written in lower-case alphabetical characters between brackets < >, and the IEEE488.2 (or SCPI)-defined <PROGRAM TYPE>s corresponding to them are written in upper-case alphabetical characters. The correspondence between each parameter and IEEE488.2 (or SCPI) is written for the various commands.

Table 6-1. Contents of Parameter Types

Parameter type	Description
<Numeric> <DECIMAL NUMERIC PROGRAM DATA>	Represents decimal numbers. A <CHARACTER PROGRAM> item, such as MINimum or MAXimum, is included in a special numeric format.
<Boolean> <BOOLEAN PROGRAM DATA> (defined by SCPI)	Represents a theoretical value. OFF or 0 corresponds to FALSE, and ON or 1 corresponds to TRUE. When 0,1 or OFF, ON are used for setting, queries return 1 or 0, never ON or OFF.
<Character> <CHARACTER PROGRAM DATA>	Represents a character data. It is possible to express a short character string corresponding to the setting contents. Both long and short forms can be used.
<Non>	Non parameter

6.2.7 Unit

The table below shows the unit types employed for this instrument.

In this manual, these unit types are written in lower-case alphabetical characters between brackets < >.

Table 6-2. Contents of Unit Types

Unit type	Description
<Freq term>	At frequency and FM deviation setting, four units can be use: "Hz", "kHz", "MHz", "GHz". Omission of the unit symbol is regarded as "Hz".
<Ampl term>	At RF output level and AF output level setting, five units can be use: "dB", "dBm", "dBu", "V", "mV", "uV". Omission of the unit symbol is regard is regard as "dBm" or "V".
<AM term>	At AM depth setting, the unit must be "%" or "PCT". Omission of the unit symbol is regard as "%".
<Time term>	At sweep time setting, three units can be use: "s", "ms", "us". Omission of the unit symbol is regard as "s".
<Non term>	Non unit.

6.2.8 Command Tree

This paragraph shows the MG3641A/MG3642A device message as a command tree for each subsystem. The messages between brackets can be omitted.

(1) Frequency Subsystem

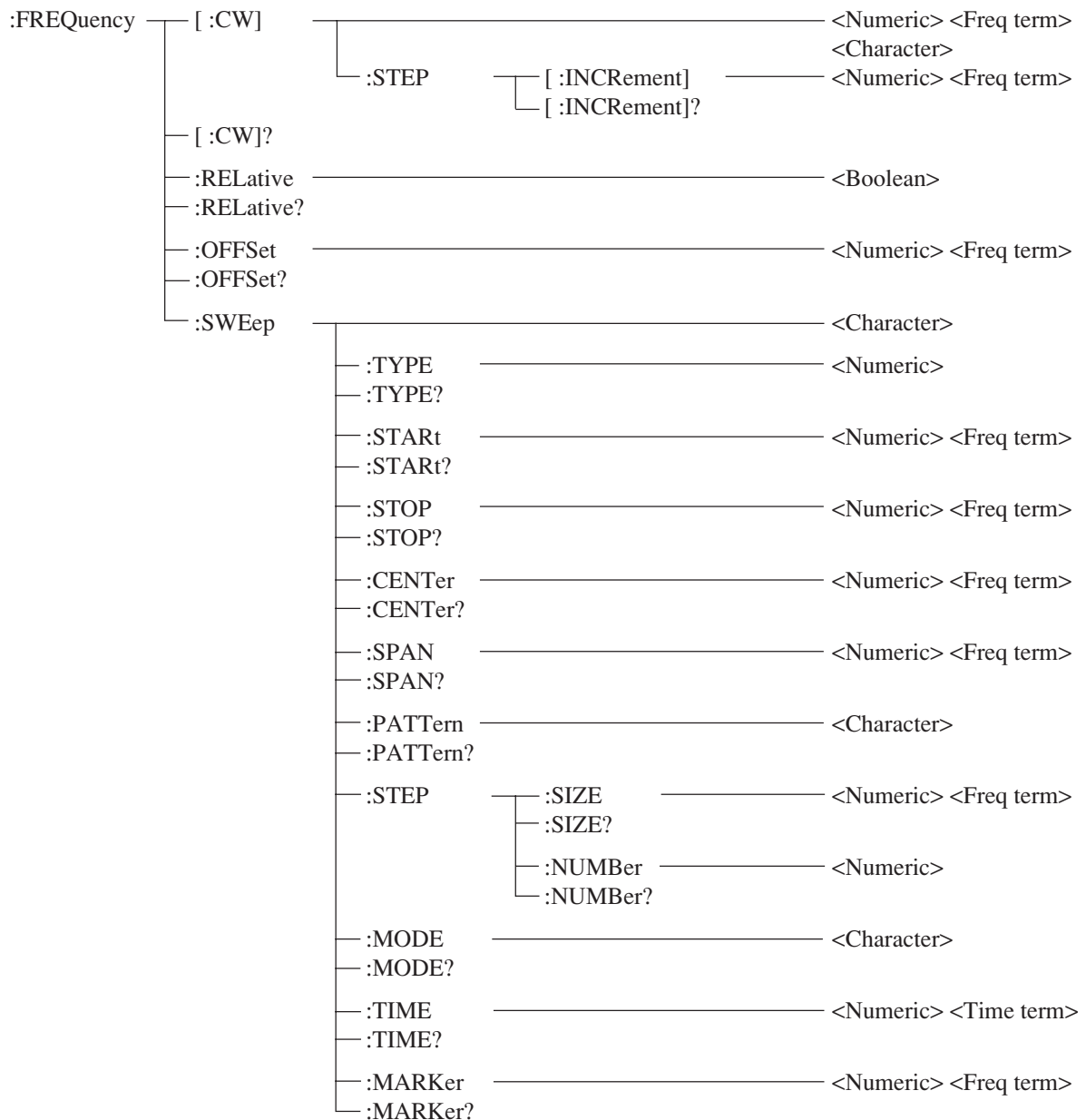

(2) Output Level Subsystem

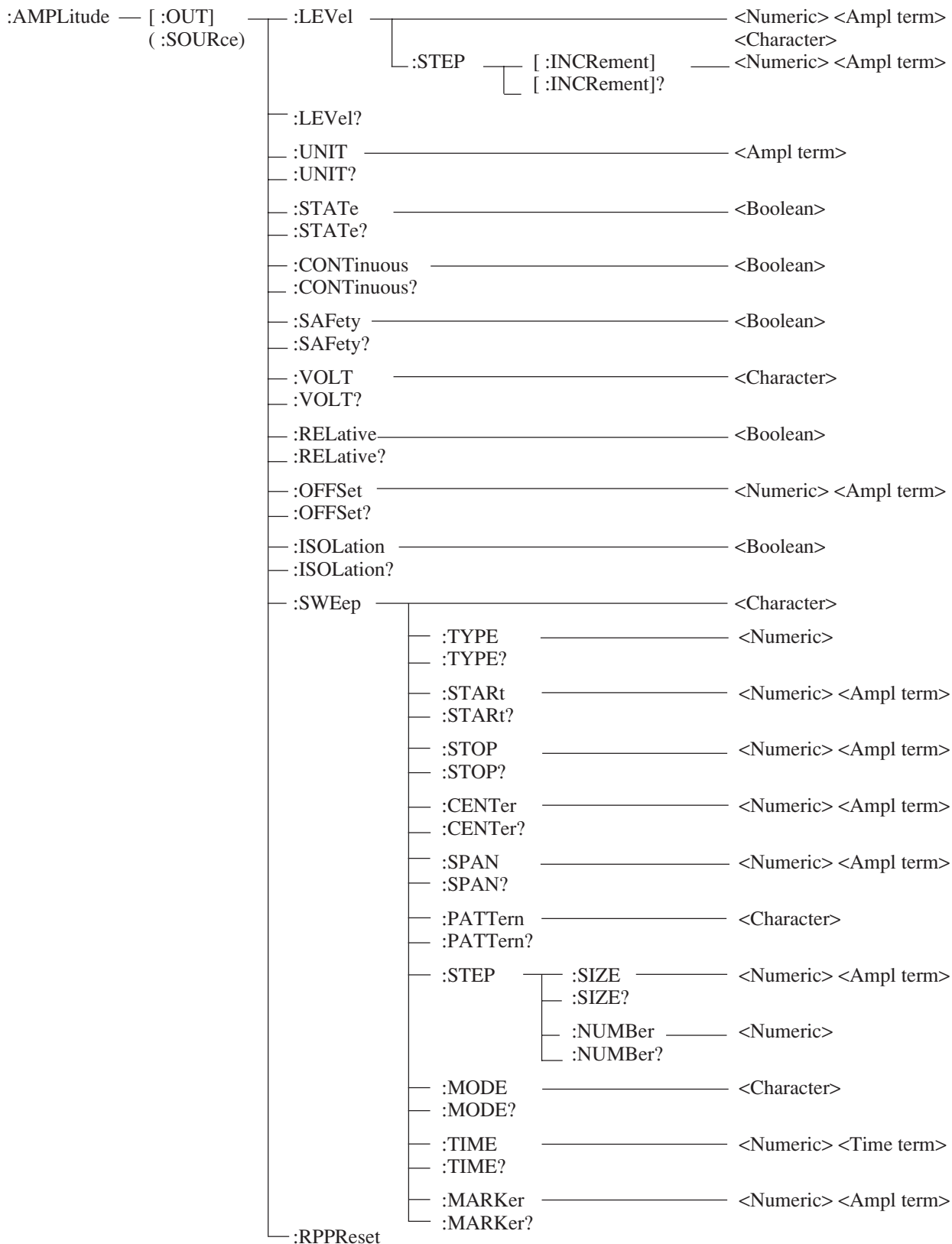

SECTION 6 GPIB

(3) AM Subsystem

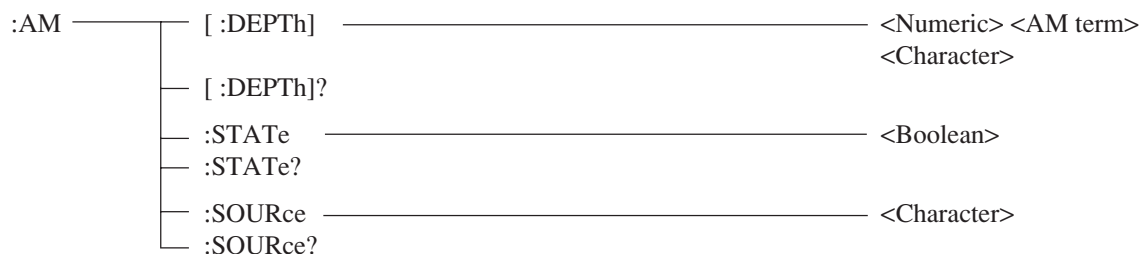

(4) FM Subsystem

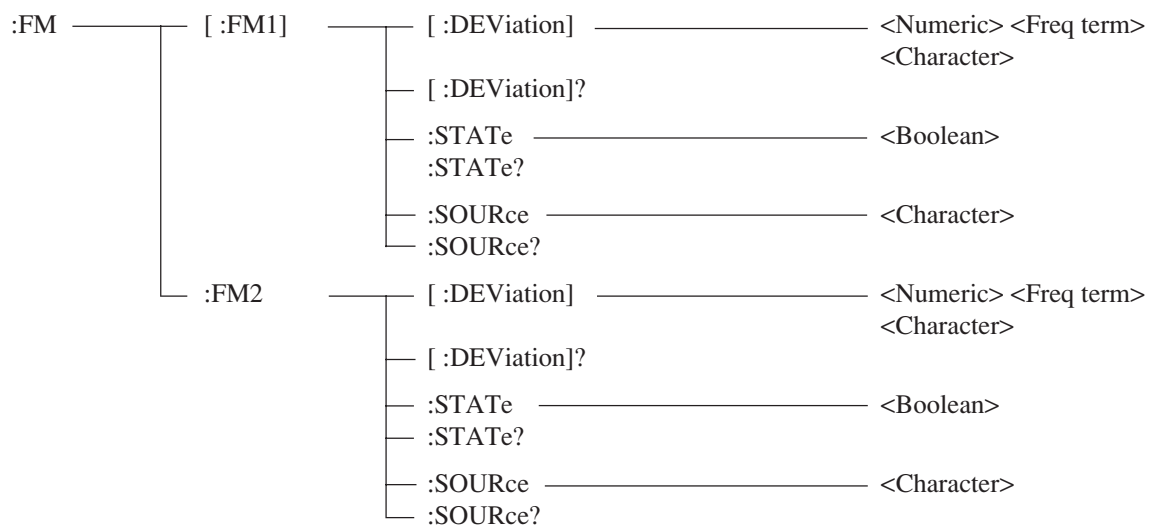

(5) PM Subsystem

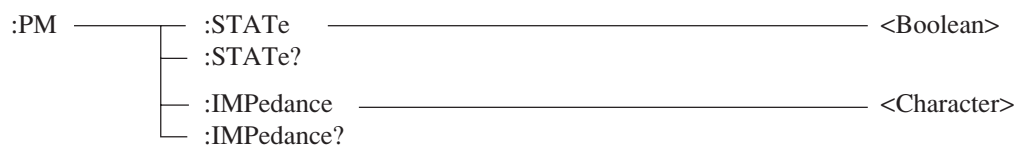

(6) Modulation Source Subsystem

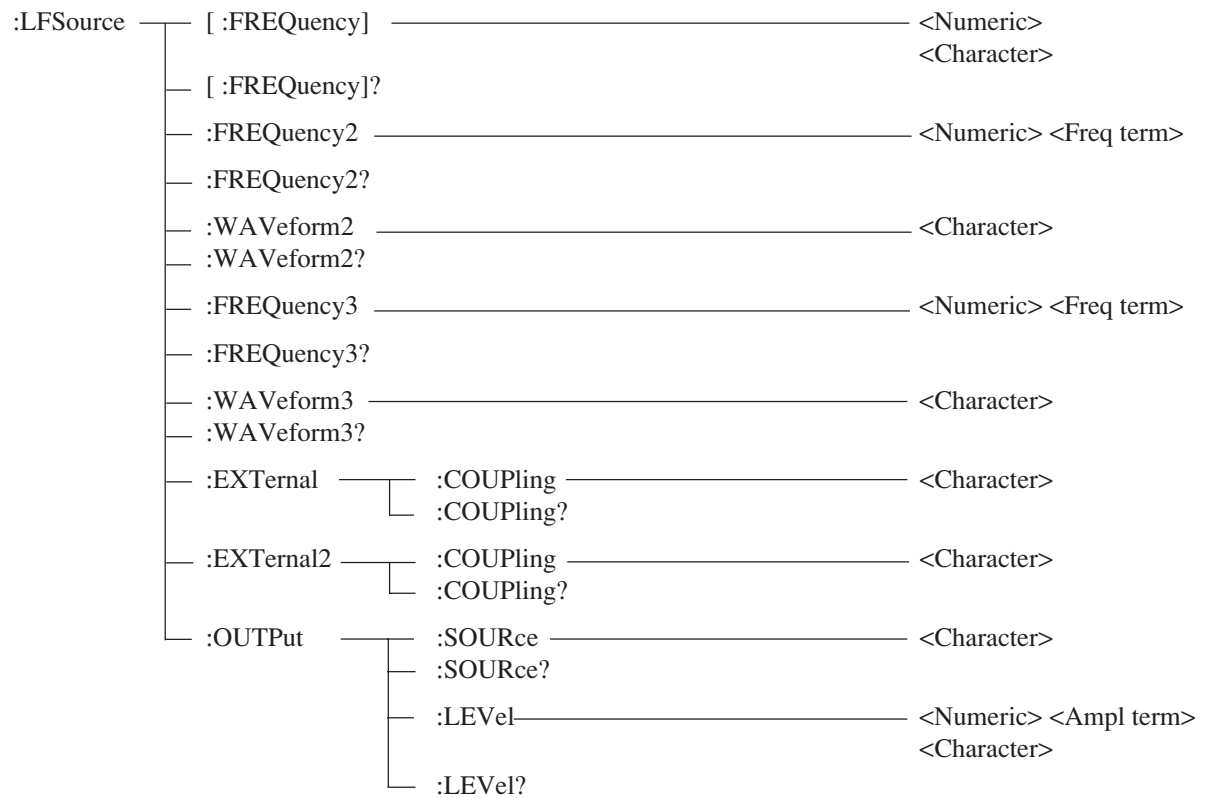

SECTION 6 GPIB

(7) Memory Subsystem

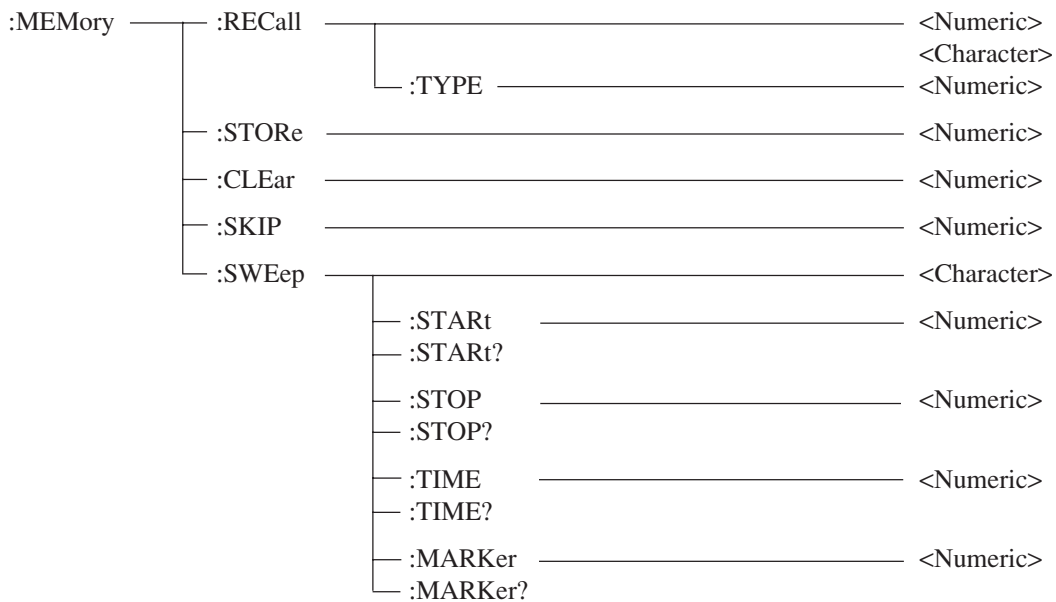

(8) Display subsystem



(9) System Subsystem

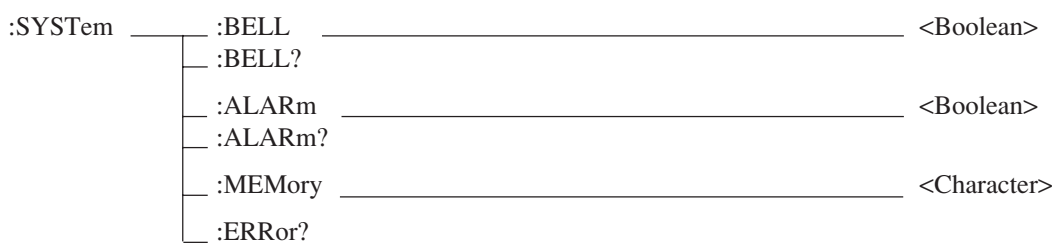

(10) Status Subsystem

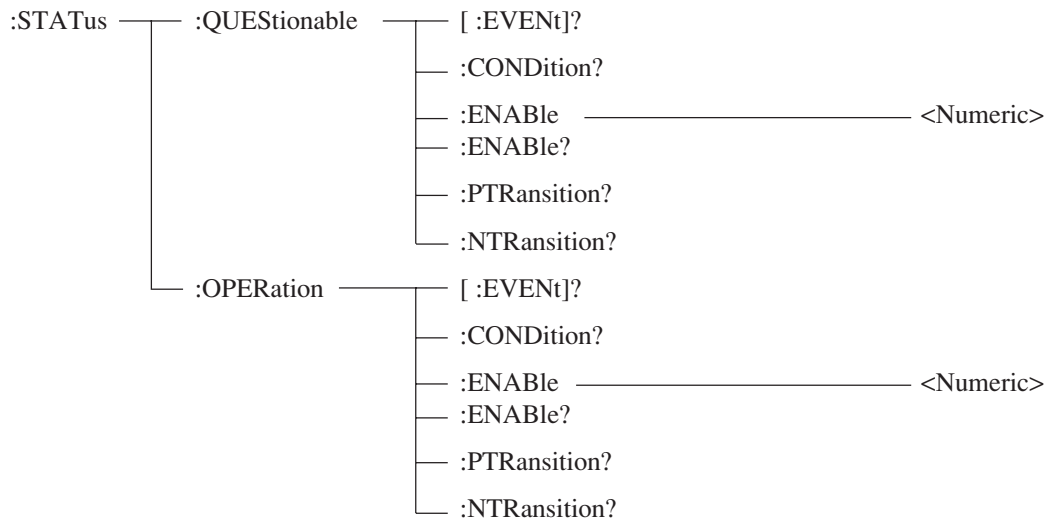

6.3 Connecting the GPIB Cable

A GPIB cable must be connected for remote control by the GPIB. The MG3641A/MG3642A supports the GPIB cable connector on the rear panel.

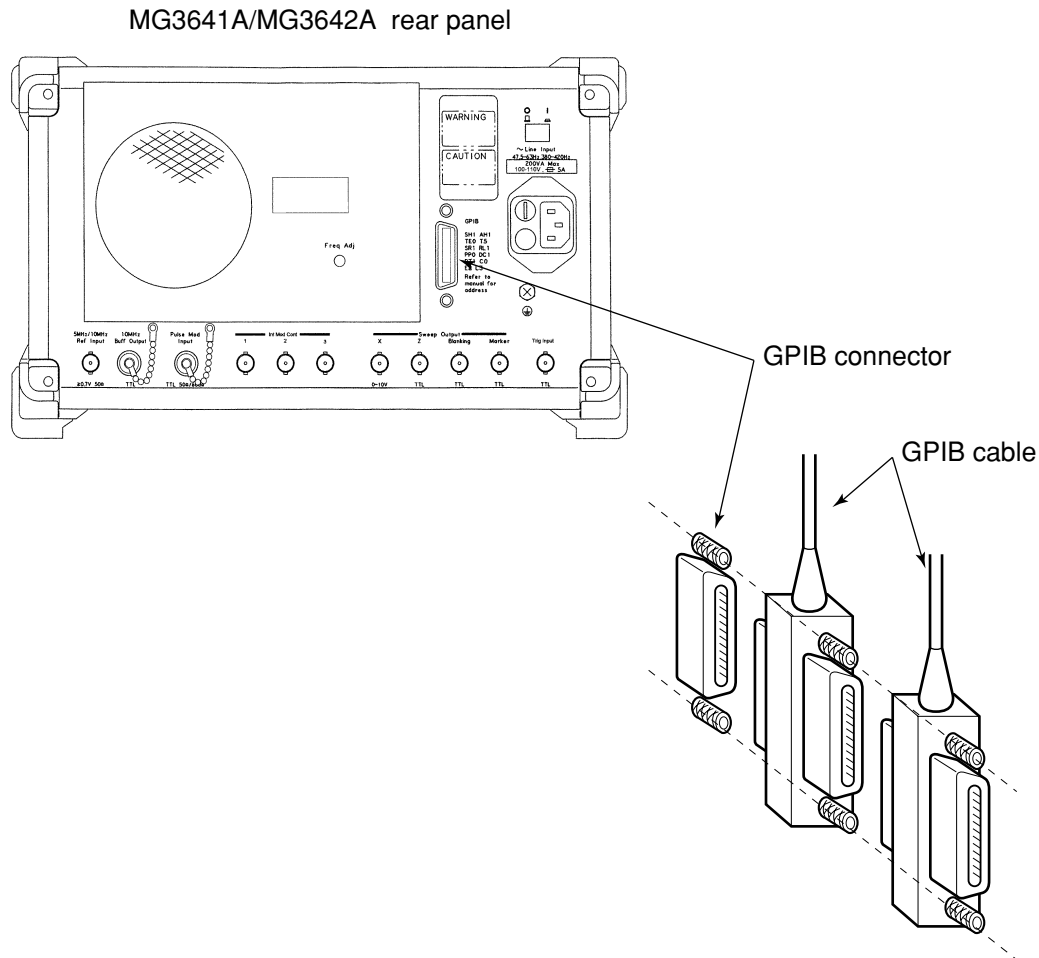

CAUTION

Turn the POWER switch off and unplug the power cord before connecting and disconnecting the GPIB cable. This is because only the signal common line of the cord may rarely be cut before the others depending the cord connection-disconnection method. In this case, if the power remains turned on, the AC leak voltage, etc. is superimposed to the IC, and the circuit parts may be damaged.

A system using GPIB is restricted as follows. The device must be connected according to the following conditions:

- Number of connectable devices ≤ 15
- Total cable length $\leq 2 \text{ m} \times \text{Number of devices (max. 20 m)}$

6.4 Device Message Format

6.4.1 Program message format

To output a program message from the controller to the MG3641A/MG3642A with a PRINT statement, the following format is used:

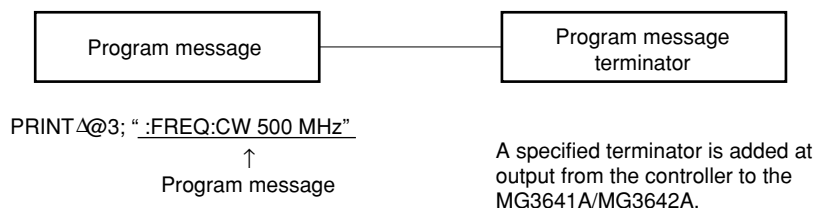

(1) Program message terminator

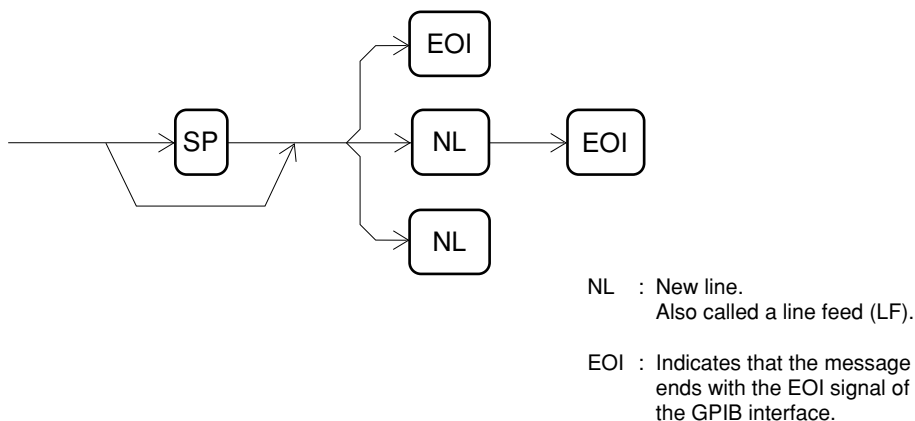

The carriage return (CR) is ignored without being processed as a terminator.

(2) Program message

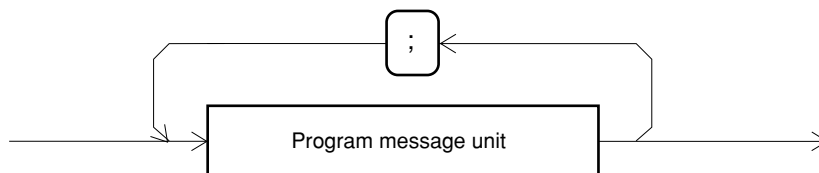

Multiple commands can be output successively by inserting a semicolon (;) between them. (For details, see Section 6.2.5.)

(3) Program message unit

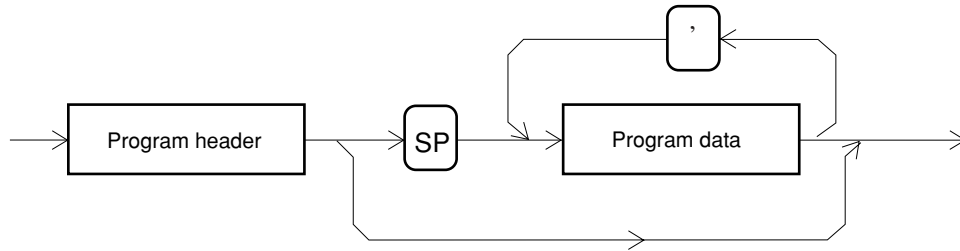

- The program header of the IEEE488.2 common command is prefixed by an asterisk (*).
- The program header of the program query is suffixed by a question mark (?).

(4) Program data

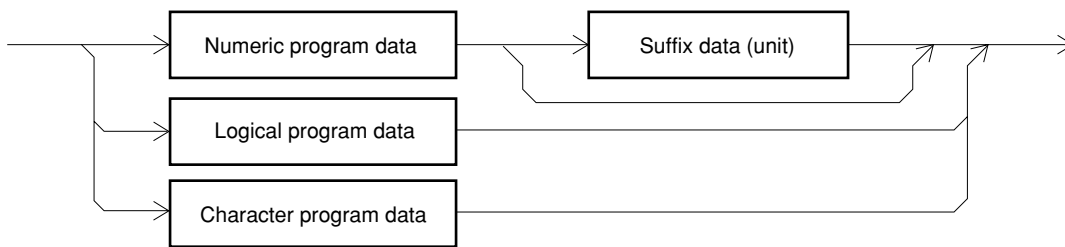

- Numeric program data

The numeric program data is indicated in two formats: integer format (NR1) and real number (fixed point) format (NR2).

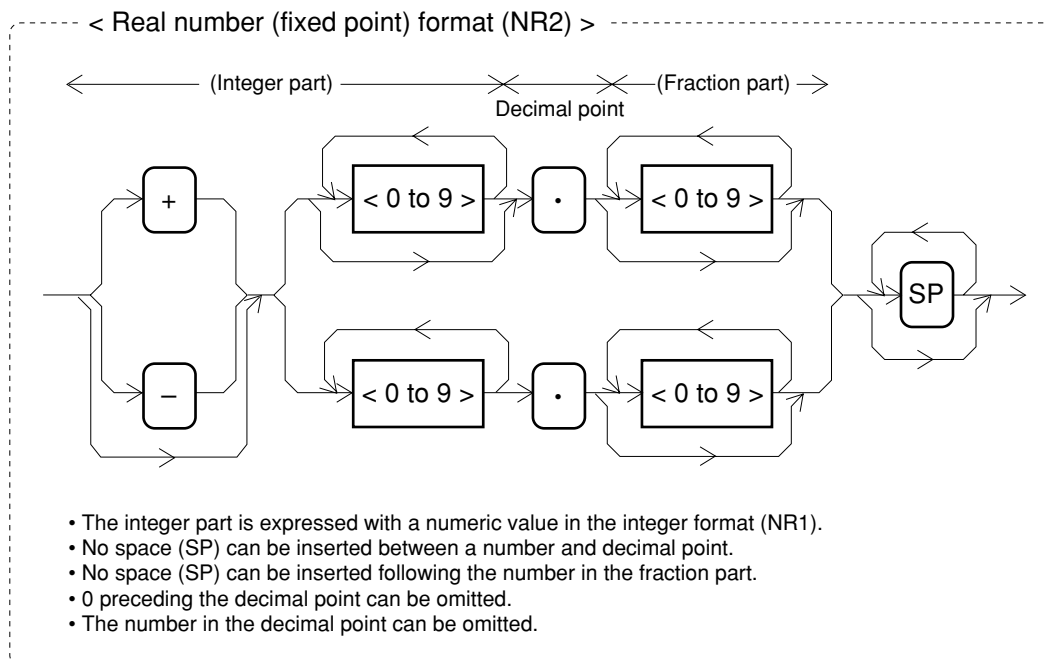
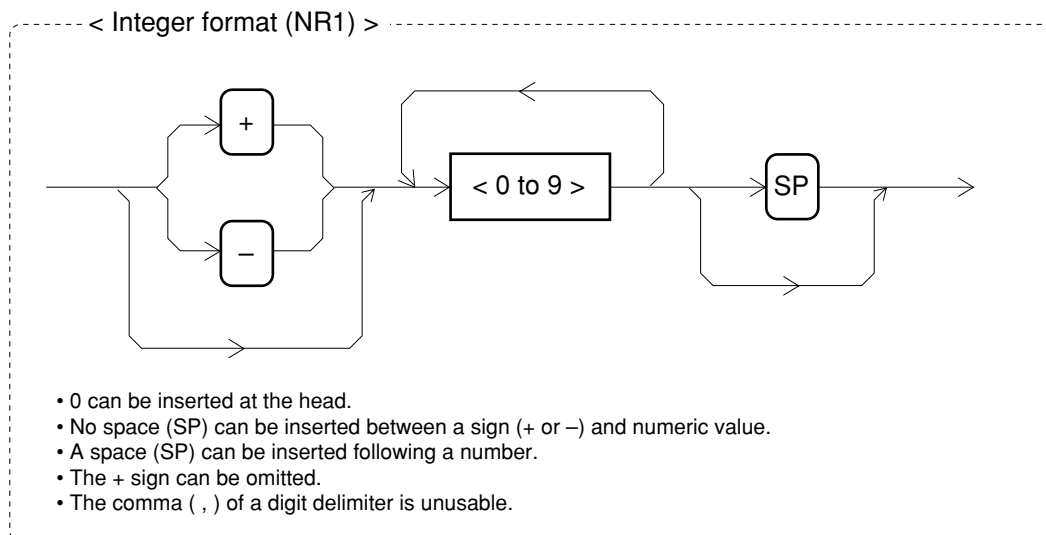

- Boolean program data

Expressed with 0 indicating false or OFF and 1 or ON indicating true. It is indicated by both methods, 0/1 and ON/OFF.

- Character program data

Determined character string data consisting of characters A to Z or a to z, numbers 0 to 9, and underbar (_).

6.4.2 Response message format

The response message is received from the MG3641A/MG3642A with an INPUT statement in the following format:



(1) Program message terminator

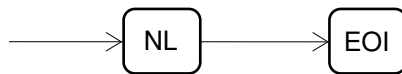

(2) Response message

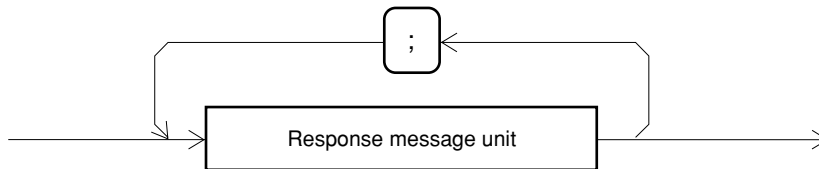

The response message consists one or multiple response message units for one or multiple program queries issued with one PRINT statement.

(3) Ordinary response message unit

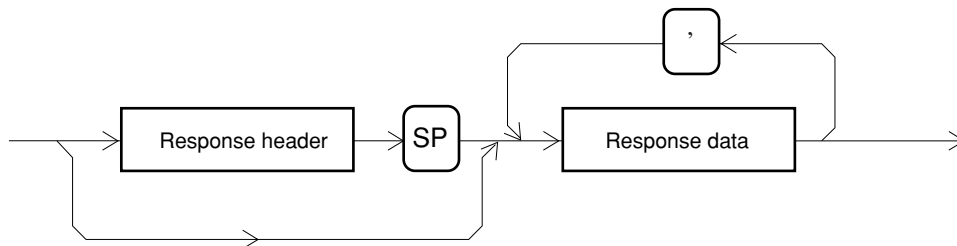

(4) Response data

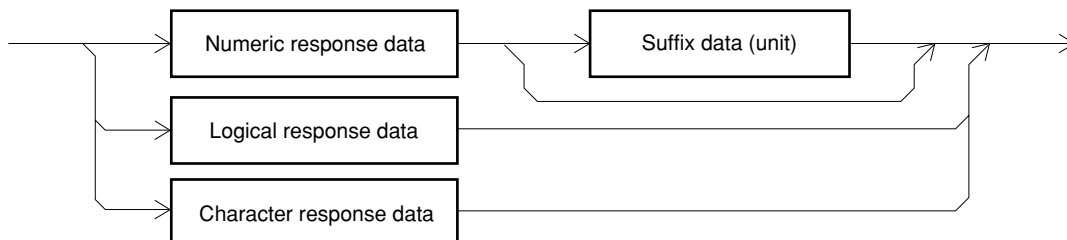

- Numeric response data

The numeric response data is expressed in the integer format (NR1) and real number (fixed point) format (NR2).

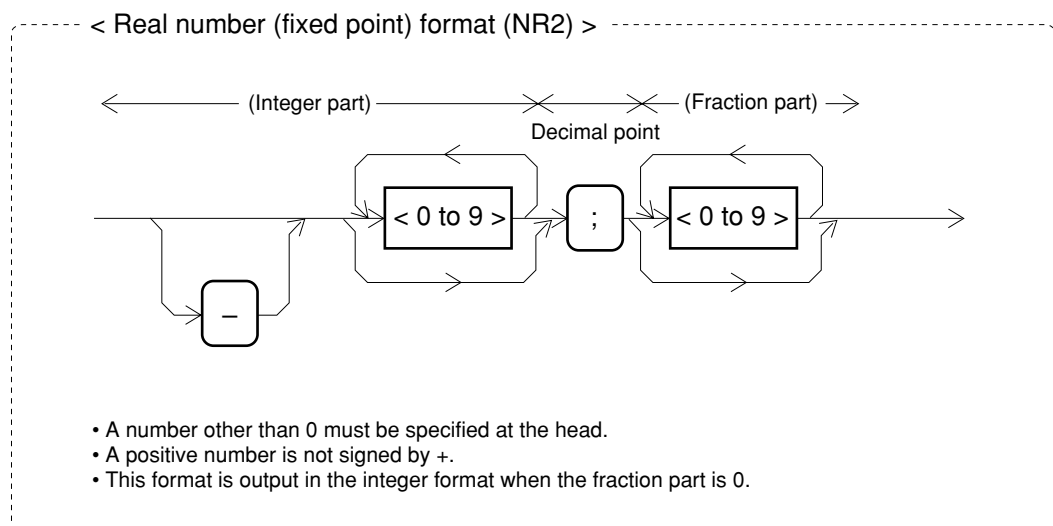
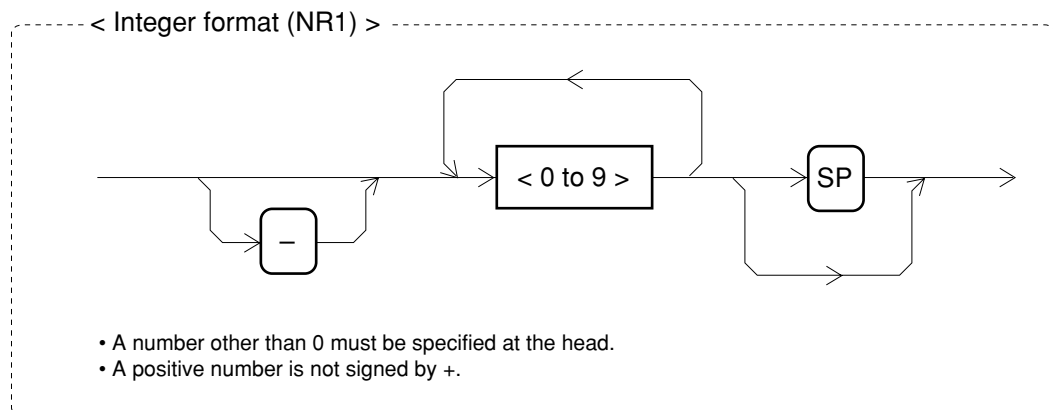

- Boolean response data

Expressed with 0 indicating false and 1 indicating true.

- Character response data

Determined character string data consisting of characters A to Z or a to z, numbers 0 to 9, and underbar (_).

6.5 Status Message

The status byte (STB) sent to the controller is based on the IEEE488.1 standard. Its bits, regarded as a status summary message, outlines the current contents of the data stored in the register and queue.

This section explains the status summary message bits, status data structure for generating them, and synchronization between the MG3641A/MG3642A using the status message and controller.

6.5.1 Status register configuration

The figure below shows the entire configuration of the MG3641A/MG3642A status register. The detail is explained for each paragraph.

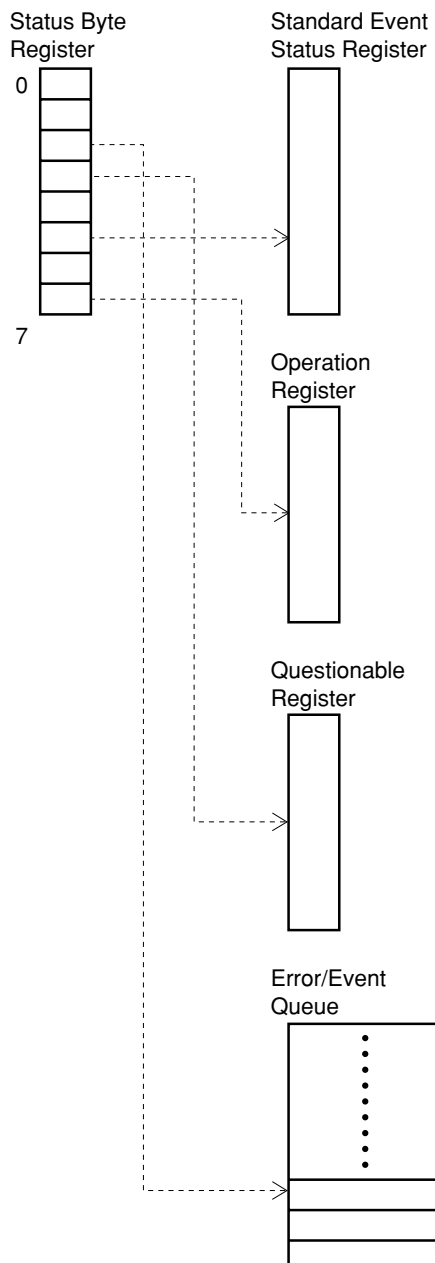

6.5.2 IEEE488.2-based status register

IEEE488.2 prescribes the following two status registers.

Status byte register	Used to set the RQS and seven summary bits. Combined with a service request enable register. SRQ bit is set on when ORs of both the status and service request enable registers are not 0. RQS, reserved in bit 6, indicates whether a service request is in an external controller.
Standard event status register	Used to set eight types of standard events the device encounters. The logical OR output bit is summarized in bit 5 of the status byte register as a summary message of the event status bit (ESB).

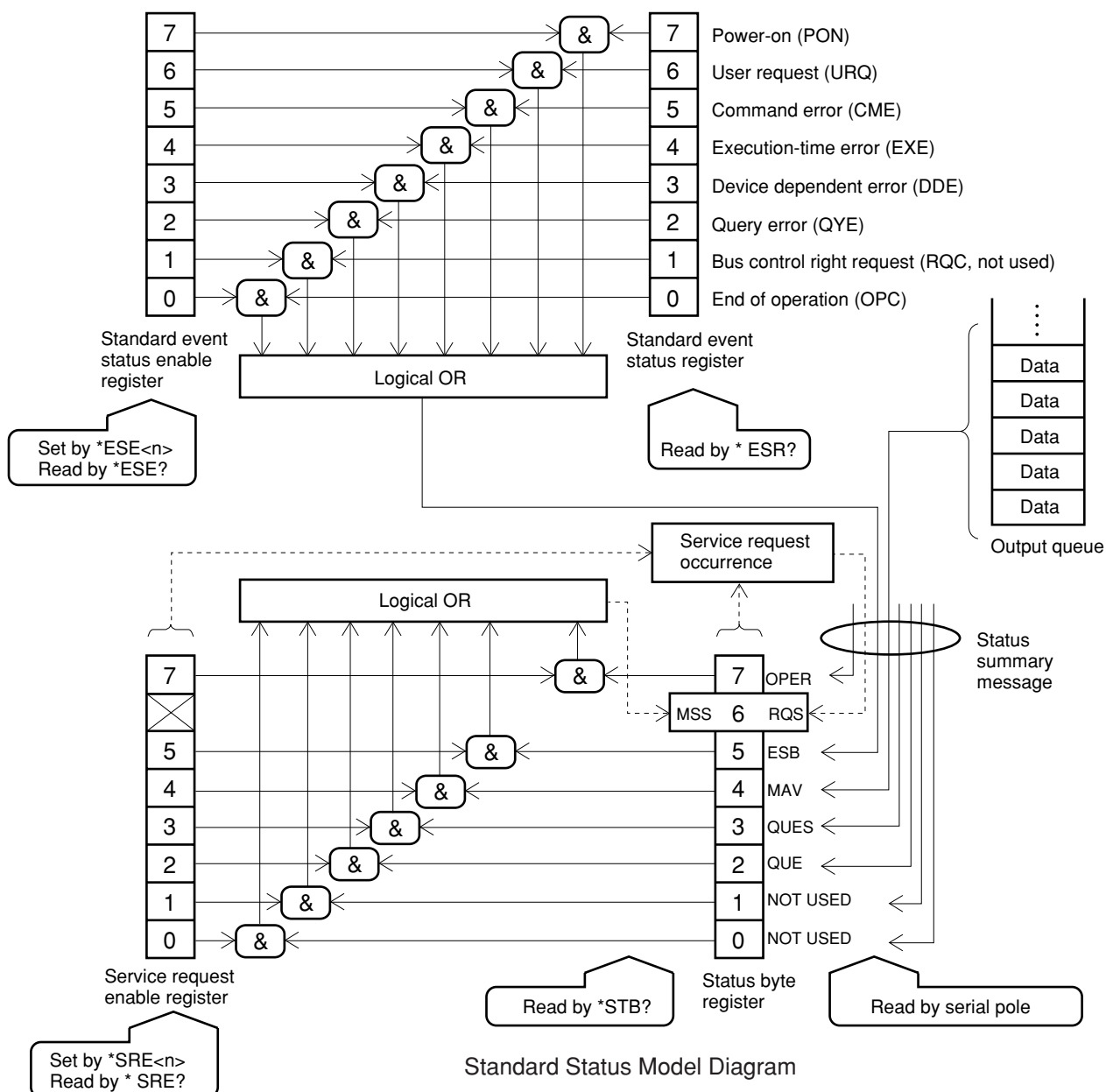

Definition of bits in status byte register

DB2	QUE	(Error/Event QUEue)	Indicates that the error/event queue is not empty.
DB3	QUES	(QUEStionable status register summary)	Summary bit of questionable status register
DB4	MAV	(Message Available)	The response buffer contains data.
DB5	ESB	(Event Summary Bit)	Summary bit of standard event status register
DB6	RQS	(ReQuest Service)	RQS message
	MSS	(Master Summary Status)	Indicates that at least one service request cause is in the device.
DB7	OPER	(OPERation status register summary)	Summary bit of operation status register

Definition of bits in standard event status register

DB0	OPC	(OPERation Complete)	Indicates all the specified operation is completed.
DB2	QYE	(QuerY Error)	Indicates that a query error occurred.
DB3	DDE	(Device Dependent Error)	Indicates a device error occurred.
DB4	EXE	(EXecution Error)	An execution error occurred.
DB5	CME	(CoMmand Error)	A command error occurred.
DB6	URQ	(User ReQuest)	User-defined bit
DB7	PON	(Power ON)	Indicates that the power was turned on.

6.5.3 SCPI standard status register

The SCPI standard contains the following registers in addition to the register configuration defined in the 488.2 standard.

OPERation register	Reports a part of the device state.
QUEStionable register	Reports the signal state.

OPERation register

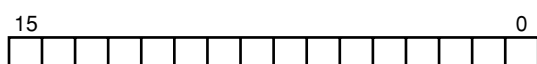

- Bit 0: Frequency Sweeping
- 1: Level Sweeping
- 2: Memory Sweeping

QUEStionable register

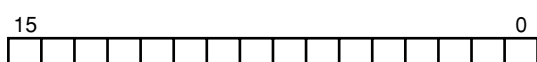

- Bit 0: AM uncal
- 1: FM uncal
- 2: Level uncal
- 3: RF amplifier abnormal
- 4: Synthesizer unlock
- 5: Reference signal abnormal
- 6: RF out shut-down by RPP

6.5.4 Reading, writing, clearing, and resetting the status register

The table below lists how to read and write each status register.

Register Name	Reading method	Writing method
Status Byte Register	Serial poll A 7-bit status byte and RQS bit are returned. The value of the status byte then remained unchanged. *STB? The contents of the status byte register and one numeric value transferred from the MSS (master summary status) summary message are returned.	None
Service Request Enable Register	*SRE?	*SRE
Standard Event Status Register	*ESR? The contents of the register are cleared after reading.	None
Standard Event Status Enable Register	*ESE? The contents of the register are not cleared after reading.	*ESE
SCPI Event Status Register	:STATus: :EVENT? The contents of the register are cleared after reading.	None
SCPI Event Status Enable Register	:STATus: :ENABLE? The contents of the register are not cleared after reading.	:STATus: :ENABLE
SCPI Positive Transition Filter	:STATus: :PTRansition? The contents of the register are not cleared after reading.	:STATus: :PTRansition
SCPI Negative Transition Filter	:STATus: :NTRansition? The contents of the register are not cleared after reading.	:STATus: :NTRansition
Error/Event Queue	:SYSTem:ERRor?	None

SECTION 6 GPIB

The table below lists how to clear and reset each status register and ranges affected by clearing and resetting.

Register name	*RST	*CLS	P-ON	STATus:PRESet	Other clear method
Status Byte Register	–	C	C	–	
Service Request Enable Register	–	–	C	–	*SRE 0
Standard Event Status Register	–	C	C	–	Cleared when the event is read by *ESR?
Standrd Event Status Enable Register	–	–	C	–	*ESE0
SCPI Event Status Register	–	C	C	–	Cleared when the event is read by :STATus ...:EVENT?
SCPI Event Status Enable Register	–	–	R	R	:STATus: :ENABLE 0
SCPI Positive Transition Filter	–	–	R	R	:STATus: :PTRansition 0
SCPI Negative Transition Filter	–	–	R	R	:STATus: :NTRansition 0
Error/Event Queue	–	C	C	–	All events are read by :SYSTem:ERRor?

–: Unchanged C: Cleared R: Reset

Each status register is cleared and reset by a *PSC common command when the power-on status clear (PSC) flag is assumed to be true and the power is turned on.

The table below lists the registers affected by the :STATus:PRESet command and indicates their reset values.

Register Name	Enable/Filter	Reset Value
OPERation status register	Enable register	All 0
QUESTionable status register	PTRansition register	All 1
	NTRansition register	All 0
INSTRument status register	Enable register	All 1
	PTRansition register	All 1
	NTRansition register	All 0
Other status register	Enable register	All 1
	PTRansition register	All 1
	NTRansition register	All 1

6.5.5 SCPI error messages

SCPI prescribes the error codes and messages as responses to an SCPI command :SYSTem:ERRor?.

This paragraph explains the MG3641A/MG3642A error messages in detail.

(1) Command error group

Error codes –100 to –199 indicate that an IEEE488.2 syntax error occurred. Bit 5 in the standard event status register of this device is set when an error occurs at report of the events below.

- At reception of a message unmatching the IEEE488.2 standard
- At reception of a header unmatching the standard of the device commands and common commands
- At sending of a group execute trigger (GET) in a program message

Error code	Message	Error detection conditions
–101	Invalid character	A header or parameter contains an invalid character.
–104	Data type error	An invalid type is specified for the parameter.
–105	GET not allowed	A group execute trigger was sent into the program message.
–112	Program mnemonic too long	The program mnemonic is specified with 12 or more characters.
–113	Undefined header	The header syntax is correct, but it is not defined in the device.
–120	Numeric data error	An error was detected in the numeric data.
–121	Invalid character in number	An invalid character is specified in the numeric data.
–130	Suffix error	A suffix error was detected.

Error code	Message	Error detection conditions
–144	Character data too long	Character data is specified with 12 or more characters.
–150	String data error	Invalid string data is specified.

(2) Execution error group

Error codes –200 to –299 indicate that an error occurred in the execution control unit of the device. Bit 4 in the standard event status register of the device is set when an error occurs at report of the events below.

- Invalid <program data> follows the header.
- The program message cannot be executed by the device state.

Error code	Message	Error detection conditions
–220	Parameter error	An error was detected in the parameter.
–222	Data out of range	The specified numeric data exceeds the typical value of the device.
–223	Too much data	The string data length exceeds the specified value.
–224	Illegal parameter value	The received parameter is unusable.
–240	Hardware error	The command cannot be executed because of a hardware fault.
–241	Hardware missing	The command cannot be executed because no option is specified.

(3) Device dependent error group

Error codes –300 to –399 indicate that a device error other than command, execution, and query errors occurred in the device. Bit 3 in the standard event status register of the device is set at occurrence of an error.

Error code	Message	Error detection conditions
–310	System error	A system error occurred.
–311	Save/recall memory lost	The save/recall memory was lost.
–350	Self-test failed	The self-diagnosis failed.

(4) Query error group

Error codes –400 to –499 indicate that a message exchange protocol error occurred in the output buffer control unit of the device. Bit 2 in the standard event status register of the device is set at occurrence of an error.

Error code	Message	Error detection conditions
–410	Query INTERRUPTED	An interrupt was generated by a new command before the device sent a response message.
–420	Query UNTERMINATED	No query corresponding to a response message to be read is sent. The query does not terminate completely.
–430	Query DEADLOCKED	An attempt was made to buffer a large amount of data exceeding a storage space.

6.6 Initializing Device

The IEEE488.2 standard prescribes the 3-level initialization types: system, bus, and message initializations.

Level	Initialization type	Description
1	Bus initialization	Initializes all the interface functions connected to the bus by the IFC message transferred from controller.
2	Message initialization	Invalidates a function that reports the initialization of the message exchange of the device specified with a GPIB bus command SDC or all GPIB devices specified with a VPIB bus command DCL and end of the operation to the controller.
3	Device initialization	Returns the device into the preceding state by *RST regardless of the past use state.

6.6.1 Bus initialization

Bus initialization by IFC statement:

The interface function of all the devices connected to the GPIB bus line is initialized by placing the IFC line into the active mode for about 100 μ s. IFC is sent only by the system controller.

6.6.2 Message initialization

Message exchange initialization by DCL or SDC bus command:

All GPIB devices or only the specified device is initialized for message exchange. The message exchange initialization is aimed at preparing so that a new command can be sent from the controller by initializing the message exchange when the message exchange unit in the device cannot be controlled from the controller because another program runs although the state set on the panel need not be changed.

DCL : Initializes the message exchange for all GPIB devices.

SDC : Initializes the message exchange only for the specified device.

6.6.3 Device initialization

Device initialization by *RST command:

The device function is returned to the preceding state regardless of the past use state. In the MG3641A/MG3642A, it is returned in the same state set when the Preset key is pressed.

6.6.4 Device state at power-on

When the power is turned on, the MG3641A/MG3642A is set into the following states:

- The device is set into the state placed when the power is turned off last.
- The input buffer and output queue are cleared.
- The parser analyzer, execution controller, and response formatter are reset.

6.7 Detailed Description of Commands

6.7.1 Frequency subsystem

<code>:FREQUENCY[:CW]</code>	<Numeric> <Freq term> or <Character>
Function	Sets the carrier frequency.
Parameter	<Numeric> = 0 Hz to 1040 MHz (MG3641A) 0 Hz to 2080 MHz (MG3642A) <Character> = UP DOWN
Unit	<Freq term> (UP,DOWN:<Non term>)
Restriction	None
<code>:FREQUENCY[:CW]?</code>	
Function	Reads out the carrier frequency.
Response	Carrier frequency
Restriction	None
<code>:FREQUENCY[:CW]:STEP[:INCREMENT]</code>	<Numeric> <Freq term>
Function	Sets the frequency step value.
Parameter	<Numeric> = 0 Hz to 1040 MHz (MG3641A) 0 Hz to 2080 MHz (MG3642A)
Unit	<Freq term>
Restriction	None
<code>:FREQUENCY[:CW]:STEP[:INCREMENT]?</code>	
Function	Reads out the frequency step value.
Response	Frequency step value
Restriction	None
<code>:FREQUENCY:RELATIVE</code>	<Boolean>
Function	Turns ON or OFF the relative frequency display mode.
Parameter	<Boolean> = ON or 1 OFF or 0
Unit	<Non term>
Restriction	None
<code>:FREQUENCY:RELATIVE?</code>	
Function	Reads out the state of relative frequency display mode.
Response	Relative frequency display mode = OFF ON
Restriction	None
<code>:FREQUENCY:OFFSET</code>	<Numeric> <Freq term>
Function	Sets the frequency offset value.
Parameter	<Numeric> = -7 GHz to 7 GHz
Unit	<Freq term>
Restriction	None

:FREQUency:OFFSet?

Function	Reads out the frequency offset value.
Response	Frequency offset value
Restriction	None

:FREQUency:SWEEp <Character>

Function	Executes frequency sweep.
Parameter	<Character> = RUN STOP PAUSE CONT
Unit	<Non term>
Restriction	None

:FREQUency:SWEEp:STARt <Numeric> <Freq term>

Function	Sets the start frequency for a sweep.
Parameter	<Numeric> = 0 Hz to 1040 MHz (MG3641A) 0 Hz to 2080 MHz (MG3642A)
Unit	<Freq term>
Restriction	None

:FREQUency:SWEEp:STARt?

Function	Reads out the start frequency for sweep.
Response	Start frequency for a sweep
Restriction	None

:FREQUency:SWEEp:STOP <Numeric> <Freq term>

Function	Sets the stop frequency for a sweep.
Parameter	<Numeric> = 0 Hz to 1040 MHz (MG3641A) 0 Hz to 2080 MHz (MG3642A)
Unit	<Freq term>
Restriction	None

:FREQUency:SWEEp:STOP?

Function	Reads out the stop frequency for a sweep.
Response	Stop frequency for a sweep
Restriction	None

:FREQUency:SWEEp:CENTer <Numeric> <Freq term>

Function	Sets the center frequency for a sweep.
Parameter	<Numeric> = 0.01 Hz to 1039.99999999 MHz (MG3641A) 0.01 Hz to 2079.99999999 MHz (MG3642A)
Unit	<Freq term>
Restriction	None

:FREQUency:SWEEp:CENTer?

Function	Reads out the center frequency for a sweep.
Response	Center frequency for a sweep
Restriction	None

SECTION 6 GPIB

- :FREQUENCY:SWEEP:SPAN <Numeric> <Freq term>
 Function Sets the span frequency for a sweep.
 Parameter <Numeric> = 0.02 Hz to 1040 MHz (MG3641A)
 0.02 Hz to 2080 MHz (MG3642A)
 Unit <Freq term>
 Restriction None
- :FREQUENCY:SWEEP:SPAN?
 Function Reads out the span frequency for a sweep.
 Response Span frequency for a sweep
 Restriction None
- :FREQUENCY:SWEEP:STEP:SIZE <Numeric> <Freq term>
 Function Sets the frequency step size for a liner sweep.
 Parameter <Numeric> = 0.01 Hz to 1040 MHz (MG3641A)
 0.01 Hz to 2080 MHz (MG3642A)
 Unit <Freq term>
 Restriction None
- :FREQUENCY:SWEEP:STEP:SIZE?
 Function Reads out the frequency step size for a liner sweep.
 Response Frequency step size for a liner sweep
 Restriction None
- :FREQUENCY:SWEEP:STEP:NUMBER <Numeric>
 Function Sets the number of frequency points for a liner sweep.
 Parameter <Numeric> = 2 to 104000000001 (MG3641A)
 2 to 208000000001 (MG3642A)
 Unit <Non term>
 Restriction None
- :FREQUENCY:SWEEP:STEP:NUMBER?
 Function Reads out the number of frequency points for a liner sweep.
 Response Number of frequency points for a liner sweep
 Restriction None
- :FREQUENCY:SWEEP:MODE <Character>
 Function Selects the frequency sweep mode.
 Parameter <Character> = AUTO
 SINGLE
 MANUAL
 Unit <Non term>
 Restriction None
- :FREQUENCY:SWEEP:MODE?
 Function Reads out the frequency sweep mode.
 Response Frequency sweep mode = AUTO
 SINGLE
 MANUAL
 Restriction None

:FREQUency:SWEep:TIME <Numeric> <Time term>	
Function	Sets the sweep time for a frequency sweep.
Parameter	<Numeric> = 0.1 ms to 600 s
Unit	<Time term>
Restriction	None
:FREQUency:SWEep:TIME?	
Function	Reads out the sweep time for a frequency sweep.
Response	Sweep time for a frequency sweep
Restriction	None
:FREQUency:SWEep:MARKer <Numeric> <Freq term>	
Function	Sets the marker frequency for a sweep.
Parameter	<Numeric> = 0.01 Hz to 1040 MHz (MG3641A) 0.01 Hz to 2080 MHz (MG3642A)
Unit	<Freq term>
Restriction	None
:FREQUency:SWEep:MARKer?	
Function	Reads out the marker frequency for a sweep.
Response	Marker frequency for a sweep
Restriction	None
:FREQUency:SWEep:PATtern	
Function	Sets the frequency sweep pattern.
Parameter	<Character> = SIZE NO LOG
Unit	<Non term>
Restriction	None
:FREQUency:SWEep:PATtern?	
Function	Reads out the frequency sweep pattern.
Response	Frequency sweep pattern = SIZE NO LOG
Restriction	None
:FREQUency:SWEep:TYPE <Numeric>	
Function	Sets the frequency sweep type.
Parameter	<Numeric> = 0 (START-STOP) 1 (CENTER-SPAN)
Unit	<Non term>
Restriction	None
:FREQUency:SWEep:TYPE?	
Function	Reads out the frequency sweep type.
Response	Frequency sweep type = 0 (START-STOP) 1 (CENTER-SPAN)
Restriction	None

6.7.2 Output level subsystem

In the output level subsystem, both “:POWer: SOURce” and “:AMPLitude[:OUT]” are valid for the first and second layers. (When the first layer is PEWer, the SOURce of the second layer cannot be omitted.) The same processing is performed in either format. “:AMPLitude[:OUT]” is used in this document.

:AMPLitude[:OUT]:LEVel <Numeric> <Ampl term> or <Character>

Function	Sets the output level.
Parameter	<Numeric> = -143 dBm to +23 dBm <Character> = UP DOWN
Unit	<Ampl term> (UP,DOWN:<None term>)
Restriction	None

:AMPLitude[:OUT]:LEVel?

Function	Reads out the output level.
Response	Output level
Restriction	None

:AMPLitude[:OUT]:LEVel:STEP[:INCRement] <Numeric> <Ampl term>

Function	Sets the output level step value.
Parameter	<Numeric> = 0.01 dB to 166 dB
Unit	<Ampl term>
Restriction	Unit is dB, only.

:AMPLitude[:OUT]:LEVel:STEP[:INCRement]?

Function	Reads out the output level step value.
Response	Output level
Restriction	None

:AMPLitude[:OUT]:LEVel:UNIT <Ampl term>

Function	Sets the output level unit.
Parameter	None
Unit	<Ampl term>
Restriction	None

:AMPLitude[:OUT][:LEVel]:UNIT?

Function	Reads out the output level unit.
Response	Output level unit = dB dBm dBu V mV uV
Restriction	None

```

:AMPLitude[:OUT]:STATe <Boolean>
    Function      Turns ON or OFF the RF output.
    Parameter     <Boolean> = ON or 1
                  OFF or 0

    Unit          <Non term>
    Restriction   None

:AMPLitude[:OUT]:STATe?
    Function      Reads out the state of RF output.
    Response      RF output = OFF
                  ON

    Restriction   None

:AMPLitude[:OUT]:CONTinuous <Boolean>
    Function      Turns ON or OFF the level continuous mode.
    Parameter     <Boolean> = ON or 1
                  OFF or 0

    Unit          <Non term>
    Restriction   None

:AMPLitude[:OUT]:CONTinuous?
    Function      Reads out the state of level continuous mode.
    Response      Level continuous mode = OFF
                  ON

    Restriction   None

:AMPLitude[:OUT]:SAFety <Boolean>
    Function      Turns ON or OFF the level safty mode
    Parameter     <Boolean> = ON or 1
                  OFF or 0

    Unit          <Non term>
    Restriction   None

:AMPLitude[:OUT]:SAFety?
    Function      Reads out the state of level safety mode.
    Response      Level safety mode = OFF
                  ON

    Restriction   None

:AMPLitude[:OUT]:VOLT <Character>
    Function      Selects the voltage display mode.
    Parameter     <Character> = EMF
                  TERM

    Unit          <Non term>
    Restriction   None

:AMPLitude[:OUT]:VOLT?
    Function      Reads out the RF voltage display mode.
    Response      Open voltage display    = EMF
                  Terminated voltage display = TERM

    Restriction   None

```

SECTION 6 GPIB

```
:AMPLitude[:OUT]:RELative <Boolean>
  Function      Turns ON or OFF the relative level display mode.
  Parameter    <Boolean> = ON or 1
                  OFF or 0
  Unit         <Non term>
  Restriction  None
```

```
:AMPLitude[:OUT]:RELative?
  Function      Reads out the state of relative level display mode.
  Response     Relative level display mode = OFF
                  ON
  Restriction  None
```

```
:AMPLitude[:OUT]:OFFSet <Numeric> <Ampl term>
  Function      Sets the output level offset value.
  Parameter    <Numeric> = -55 dB to 55 dB
  Unit         <Ampl term>
  Restriction  Unit is dB, only.
```

```
:AMPLitude[:OUT]:OFFSet?
  Function      Reads out the output level offset value.
  Response     Level offset value
  Restriction  None
```

```
:AMPLitude[:OUT]:ISOLation <Boolean>
  Function      Turns ON or OFF the isolation mode.
  Parameter    <Boolean> = ON or 1
                  OFF or 0
  Unit         <Non term>
  Restriction  None
```

```
:AMPLitude[:OUT]:ISOLation?
  Function      Read out the state of isolation mode.
  Response     Isolation mode = OFF
                  ON
  Restriction  None
```

```
:AMPLitude[:OUT]:SWEEP <Character>
  Function      Executes output level sweep.
  Parameter    <Character> = RUN
                  STOP
                  PAUSE
                  CONT
  Unit         <Non term>
  Restriction  None
```

```
:AMPLitude[:OUT]:SWEEP:STARt <Numeric> <Ampl term>
  Function      Sets the start level for a sweep.
  Parameter    <Numeric> = -143 dBm to +23 dBm
  Unit         <Ampl term>
  Restriction  None
```

:AMPLitude[:OUT]:SWEep:STArT?

Function	Reads the start level for a sweep.
Response	Start level for a sweep
Restriction	None

:AMPLitude[:OUT]:SWEep:STOP <Numeric> <Ampl term>

Function	Sets the stop level for a sweep.
Parameter	<Numeric> = -142.99 dBm to +22.99 dBm
Unit	<Ampl term>
Restriction	None

:AMPLitude[:OUT]:SWEep:STOP?

Function	Reads the stop level for a sweep.
Response	Stop level for sweep
Restriction	None

:AMPLitude[:OUT]:SWEep:CENTer <Numeric> <Ampl term>

Function	Sets the center level for a sweep.
Parameter	<Numeric> = -142.99 dBm to +22.99 dBm
Unit	<Ampl term>
Restriction	None

:AMPLitude[:OUT]:SWEep:CENTer?

Function	Reads out the center level for a sweep.
Response	Center level for a sweep
Restriction	None

:AMPLitude[:OUT]:SWEep:SPAN <Numeric> <Ampl term>

Function	Sets the span level for a sweep.
Parameter	<Numeric> = 0.02 dB to 20 dB
Unit	<Ampl term>
Restriction	Unit is dB, only.

:AMPLitude[:OUT]:SWEep:SPAN?

Function	Reads out the span level for a sweep.
Response	Span level for a sweep
Restriction	None

:AMPLitude[:OUT]:SWEep:STEP:SIZE <Numeric> <Ampl term>

Function	Sets the level step size for a sweep.
Parameter	<Numeric> = 0.01 dB to 20 dB
Unit	<Ampl term>
Restriction	None

:AMPLitude[:OUT]:SWEep:STEP:SIZE?

Function	Reads out the level step size for a sweep.
Response	Step size for a sweep
Restriction	None

:AMPLitude[:OUT]:SWEep:STEP:NUMBER <Numeric>

Function Sets the number of level points for a sweep.
 Parameter <Numeric> = 2 to 2001
 Unit <Non term>
 Restriction None

:AMPLitude[:OUT]:SWEep:STEP:NUMBER?

Function Reads out the number of level points for a sweep.
 Response Number of level points for a sweep
 Restriction None

:AMPLitude[:OUT]:SWEep:MODE <Character>

Function Selects the level sweep mode.
 Parameter <Character> = AUTO
 SINGLE
 MANUAL
 Unit <Non term>
 Restriction None

:AMPLitude[:OUT]:SWEep:MODE?

Function Reads out the level sweep mode.
 Response Level sweep mode = AUTO
 SINGLE
 MANUAL
 Restriction None

:AMPLitude[:OUT]:SWEep:TIME <Numeric> <Time term>

Function Sets the sweep time for a level sweep.
 Parameter <Numeric> = 0.1 ms to 600 s
 Unit <Time term>
 Restriction None

:AMPLitude[:OUT]:SWEep:TIME?

Function Reads out the sweep time for a level sweep.
 Response Sweep time for a level sweep.
 Restriction None

:AMPLitude[:OUT]:SWEep:MARKer <Numeric> <Ampl term>

Function Sets the marker level for a sweep.
 Parameter <Numeric> = -143 to +23 dBm
 Unit <Ampl term>
 Restriction None

:AMPLitude[:OUT]:SWEep:MARKer?

Function Reads out the marker level for a sweep.
 Response Marker level for a sweep
 Restriction None

:AMPLitude[:OUT]:SWEep:PATtern <Character>
 Function Sets the output level sweep pattern.
 Parameter <Character> = SIZE
 NO
 Unit <Non term>
 Restriction None

:AMPLitude[:OUT]:SWEep:PATtern?
 Function Reads out the output level pattern.
 Response Output level pattern = SIZE
 NO
 Restriction None

:AMPLitude[:OUT]:SWEep:TYPE <Numeric>
 Function Sets the output level sweep type.
 Parameter <Numeric> = 0 (START-STOP)
 1 (CENTER-SPAN)
 Unit <Non term>
 Restriction None

:AMPLitude[:OUT]:SWEep:TYPE?
 Function Reads the output level sweep type.
 Response Output level sweep type = 0 (START-STOP)
 1 (CENTER-SPAN)
 Restriction None

:AMPLitude:RPPReset
 Function Reset the reverse power protection circuit
 Parameter None
 Unit <Non term>
 Restriction None

6.7.3 AM subsystem

:AM[:DEPTh] <Numeric> <AM term> or <Character>	
Function	Sets the AM depth.
Parameter	<Numeric> = -100 to 100 % <Character> = UP DOWN
Unit	<AM term> (UP,DOWN: <None term>)
Restriction	Modulation source polarity can be changed by entering negative AM depth value.
:AM[:DEPTh]?	
Function	Reads out the AM depth.
Response	AM depth.
Restriction	None
:AM:STATe <Boolean>	
Function	Turns ON or OFF the AM.
Parameter	<Boolean> = ON or 1 OFF or 0
Unit	<Non term>
Restriction	None
:AM:STATe?	
Function	Reads out the state of AM.
Response	AM = OFF ON
Restriction	None
:AM:SOURce <Character>	
Function	Selects the AM modulation source.
Parameter	<Character> = INT1 INT2 INT3 EXT1 EXT2
Unit	<Non term>
Restriction	None
:AM:SOURce?	
Function	Reads the AM modulation source.
Response	AM modulation source = INT1 INT2 INT3 EXT1 EXT2
Restriction	None

6.7.4 FM subsystem

:FM[:FM1][:DEVIation] <Numeric> <Freq term> or <Character>	
Function	Sets the FM1 deviation.
Parameter	<Numeric> = -1024 kHz to 1024 kHz (MG3641A) -2048 kHz to 2048 kHz (MG3642A) <Character> = UP DOWN
Unit	<Freq term> (UP,DOWN<Non Term>)
Restriction	Modulation source porality can be changed by entering negative FM1 deviation value.
:FM[:FM1][:DEVIation]?	
Function	Reads out the FM1 deviation.
Response	FM1 deviation
Restriction	None
:FM[:FM1]:STATe <Boolean>	
Function	Turns ON or OFF the FM1.
Parameter	<Boolean> = ON or 1 OFF or 0
Unit	<Non term>
Restriction	None
:FM[:FM1]:STATe?	
Function	Reads out the state of FM1.
Response	FM1 = OFF ON
Restriction	None
:FM[:FM1]:SOURce <Character>	
Function	Selects the FM1 modulation source.
Parameter	<Character> = INT1 INT2 INT3 EXT1 EXT2
Unit	<Non term>
Restriction	None
:FM[:FM1]:SOURce?	
Function	Reads out the FM1 modulation source.
Response	FM1 modulation source = INT1 INT2 INT3 EXT1 EXT2
Restriction	None

SECTION 6 GPIB

:FM:FM2[:DEVIation] <Numeric> <Freq term> or <Character>
 Function Sets the FM2 deviation.
 Parameter <Numeric> = -1024 kHz to 1024 kHz (MG3641A)
 -2048 kHz to 2048 kHz (MG3642A)
 <Character> = UP
 DOWN
 Unit <Freq term>
 (UP,DOWN<Non Term>)
 Restriction Modulation source porality can be changed by entering negative FM2 deviation value.

:FM:FM2[:DEVIation]?
 Function Reads out the FM2 deviation.
 Response FM2 deviation
 Restriction None

:FM:FM2:STATe <Boolean>
 Function Turns ON or OFF the FM2.
 Parameter <Boolean> = ON or 1
 OFF or 0
 Unit <Non term>
 Restriction None

:FM:FM2:STATe?
 Function Reads out the state of FM2.
 Response FM2 = OFF
 ON
 Restriction None

:FM:FM2:SOURce <Character>
 Function Selects the FM2 modulation source.
 Parameter <Character> = INT1
 INT2
 INT3
 EXT1
 EXT2
 Unit <Non term>
 Restriction None

:FM:FM2:SOURce?
 Function Reads out the FM2 modulation source.
 Response FM2 modulation source = INT1
 INT2
 INT3
 EXT1
 EXT2
 Restriction None

6.7.5 PM subsystem

:PM:STATe <Boolean>

Function	Turns ON or OFF the pulse modulation.
Parameter	<Boolean> = ON or 1 OFF or 0
Unit	<Non term>
Restriction	None

:PM:STATe?

Function	Reads out the state of pulse modulation.
Response	Pulse modulation = OFF ON
Restriction	None

:PM:IMPedance <Character>

Function	Selects the impedance of pulse modulation input.
Parameter	<Character> = HIGH (600 Ω) LOW (50 Ω)
Unit	<Non term>
Restriction	None

:PM:IMPedance?

Function	Reads out the state of impedance of pulse modulation input.
Response	Impedance of pulse modulation input = HIGH LOW
Restriction	None

6.7.6 Modulation source subsystem

```

:LFSOURCE:FREQUENCY <Numeric> or <Character>
  Function      Sets the frequency of Int1.
  Parameter     <Numeric> = 0 (400 Hz)
                  1 (1 kHz)
                  <Character> = 400 Hz
                  1 kHz
  Unit          <Non term>
  Restriction   None

:LFSOURCE:FREQUENCY?
  Function      Reads out the frequency of Int1.
  Response      Frequency of Int1
  Restriction   None

:LFSOURCE:FREQUENCY2 <Numeric> <Freq term>
  Function      Sets the frequency of Int2.
  Parameter     <Numeric> = 0.01 Hz to 400 kHz
  Unit          <Freq term>
  Restriction   None

:LFSOURCE:FREQUENCY2?
  Function      Reads out the frequency of Int2.
  Response      Frequency of Int2
  Restriction   None

:LFSOURCE:WAVEFORM2 <Character>
  Function      Sets the wave form of Int2.
  Parameter     <Character> = SIN
                  TRI
                  SAW
                  SQR
  Unit          <Non term>
  Restriction   None

:LFSOURCE:WAVEFORM2?
  Function      Reads out the wave form of Int2.
  Response      Wave form of Int2 = SIN
                  TRI
                  SAW
                  SQR
  Unit          <Non term>
  Restriction   None

:LFSOURCE:FREQUENCY3 <Numeric> <Freq term>
  Function      Sets the frequency of Int3.
  Parameter     <Numeric> = 0.01 Hz to 400 kHz
  Unit          <Freq term>
  Restriction   None

```

:LFSOURCE:FREQUENCY3?
 Function Reads out the frequency of Int3.
 Response Frequency of Int3
 Restriction None

:LFSOURCE:WAVEFORM3 <Character>
 Function Sets the wave form of Int3.
 Parameter <Character> = SIN
 TRI
 SAW
 SQR
 Unit <Non term>
 Restriction None

:LFSOURCE:WAVEFORM3?
 Function Reads the wave form of Int3.
 Response Wave form of Int3 = SIN
 TRI
 SAW
 SQR
 Restriction None

:LFSOURCE:EXTERNAL:COUPLING <Character>
 Function Selects the coupling of Ext1.
 Parameter <Character> = AC
 DC
 Unit <Non term>
 Restriction None

:LFSOURCE:EXTERNAL:COUPLING?
 Function Reads out the coupling of Ext1.
 Parameter Coupling = AC
 DC
 Restriction None

:LFSOURCE:EXTERNAL2:COUPLING <Character>
 Function Selects the coupling of Ext2.
 Parameter <Character> = AC
 DC
 Restriction None

:LFSOURCE:EXTERNAL2:COUPLING?
 Function Reads out the coupling of Ext2.
 Parameter Coupling = AC
 DC
 Restriction None

SECTION 6 GPIB

:LFSOURCE:OUTPut:LEVel <Numeric>

Function Sets the AF output level.
Parameter <Numeric> = 0 to 4 V
Unit <Ampl term>
Restriction Units are V, mV, and uV, only.

:LFSOURCE:OUTPut:LEVel?

Function Reads out the AF output level.
Response AF output level.
Restriction None

:LFSOURCE:OUTPut:SOURce <Character>

Function Selects the source of AF output.
Parameter <Character> = INT1
INT2
INT3
EXT1
EXT2
OFF
Unit <Non term>
Restriction None

:LFSOURCE:OUTPut:SOURce?

Function Reads out the source of AF output.
Response Source of AF output = INT1
INT2
INT3
EXT1
EXT2
OFF
Restriction None

6.7.7 MEMORY subsystem

:MEMory:RECall <Numeric> or <Character>	
Function	Recall from the memory.
Parameter	<Numeric> = 0 to 999 <Character> = UP DOWN
Unit	<Non term>
Restriction	None
:MEMory:RECall:TYPE <Numeric>	
Function	Selects the recall type of the memory.
Parameter	<Numeric> = 0 (ALL) 1 (FREQ) 2 (FREQ&LEVEL)
Unit	<Non term>
Restriction	None
:MEMory:STORe <Numeric>	
Function	Store to the memory.
Parameter	<Numeric> = 0 to 19
Unit	<Non term>
Restriction	None
:MEMory:SKIP <Numeric>	
Function	Sets the skip of memory block.
Parameter	<Numeric> = 0 to 19
Unit	<Non term>
Restriction	None
:MEMory:CLEar <Numeric>, <Numeric>	
Function	Clear the memory.
Parameter	<Numeric> = 0 to 999
Unit	<Non term>
Restriction	None
:MEMory:SWEep <Character>	
Function	Executes the memory sweep.
Parameter	<Character> = RUN STOP PAUSE CONT
Unit	<Non term>
Restriction	None
:MEMory:SWEep:STARt <Numeric>	
Function	Sets the start address for a sweep.
Parameter	<Numeric> = 0 to 999
Unit	<Non term>
Restriction	None

:MEMory:SWEep:StARt?	
Function	Reads out the start address for a sweep.
Response	Start address for a sweep.
Restriction	None
:MEMory:SWEep:StOP : <Numeric>	
Function	Sets the stop address for a sweep.
Parameter	<Numeric> = 0 to 999
Unit	<Non term>
Restriction	None
:MEMory:SWEep:StOP?	
Function	Reads out the stop address for a sweep.
Response	Stop address for a sweep.
Restriction	None
:MEMory:SWEep:MODe <Character>	
Function	Selects the memory sweep mode.
Parameter	<Character> = AUTO SINGLE MANUAL
Unit	<Non term>
Restriction	None
:MEMory:SWEep:MODe?	
Function	Reads out the memory sweep mode.
Response	Memory sweep mode = AUTO SINGLE MANUAL
Restriction	None
:MEMory:SWEep:TiME <Numeric>	
Function	Sets the sweep time for a memory sweep.
Parameter	<Numeric> = 0.1 ms to 600 s
Unit	<Time term>
Restriction	None
:MEMory:SWEep:TiME?	
Function	Reads out the sweep time for a memory sweep.
Response	Sweep time for a memory sweep.
Restriction	None
:MEMory:SWEep:MArKer < Numeric>	
Function	Sets the marker memory for a sweep.
Parameter	<Numeric> = 0 to 999
Unit	<Non term>
Restriction	None
:MEMory:SWEep:MArKer?	
Function	Reads the marker memory for a sweep.
Response	Marker memory for a sweep.
Restriction	None

6.7.8 Display subsystem

:DISPlay:STATe <Numeric>

Function	Turns ON or OFF the display.
Parameter	<Numeric> = 0 (All OFF) 1 (7-segments only) 2 (All ON)
Unit	<Non term>
Restriction	None

:DISPlay:STATe?

Function	Reads out the state of display.
Response	State of display = 0 (All OFF) 1 (7-segments only) 2 (All ON)
Restriction	None

:DISPlay:MENU <Character>

Function	Selects the menu of multi menu display.
Parameter	<Character> = MAIN1 MAIN2 MODULATION SOURCE FSWEEP1 FSWEEP2 FSWEEP3 FSWEEP4 FSWEEP5 FSWEEP6 LSWEEP1 LSWEEP2 LSWEEP3 LSWEEP4 LSWEEP5 LSWEEP6 MSWEEP1 MSWEEP2 AF OFFSET MEMORY1 MEMORY2 GPIB SYSTEM1 SYSTEM2 TRIGGER OPTION
Unit	<Non term>
Restriction	None

6.7.9 System subsystem

:SYSTem:BELL <Boolean>

Function	Turns ON or OFF the bell.
Parameter	<Boolean> = ON or 1 OFF or 0
Unit	<Non term>
Restriction	None

:SYSTem:BELL?

Function	Reads out the state of bell.
Response	Bell = OFF ON
Restriction	None

:SYSTem:ALARm <Boolean>

Function	Turns ON or OFF the alarm.
Parameter	<Boolean> = ON or 1 OFF or 0
Unit	<Non term>
Restriction	None

:SYSTem:ALARm?

Function	Reads out the state of alarm.
Response	Alarm = OFF ON
Restriction	None

:SYSTem:MEMory <Character>

Function	Sets the initial memory.
Parameter	<Character> = SET CLEAR
Restriction	None

:SYSTem:ERRor?

Function	Reads out the error.
Response	Error No.
Restriction	None

*For the error numbers, refer to the SCPI Command Reference (1995 Volume 2).

:SYSTem:TRIGger?

Function	Reads out the trigger program.
Response	Trigger program
Restriction	None

6.7.10 Status subsystem

:STATus:QUEStionable[:EVENT]?

Function Reads out the questionable register event status.
 Response Register = 0 to 65535
 Restriction None

:STATus:QUEStionable:CONDition?

Function Reads out the questionable register condition status.
 Response Register = 0 to 65535
 Restriction None

:STATus:QUEStionable:ENABle <Numeric>

Function Sets the questionable register enable data.
 Parameter Register = 0 to 65535
 Restriction None

:STATus:QUEStionable:ENABle?

Function Reads out the questionable register enable data.
 Response Register = 0 to 65535
 Restriction None

:STATus:QUEStionable:PTRansition?

Function Reads out the questionable register transition filter (positive).
 Response Always 65535
 Restriction None

:STATus:QUEStionable:NTRansition?

Function Reads out the questionable register transition filter (negative).
 Response Always 0
 Restriction None

:STATus:OPERation[:EVENT]?

Function Reads out the operation register event status.
 Response Register = 0 to 65535
 Restriction None

:STATus:OPERation:CONDition?

Function Reads out the operation register condition status.
 Response Register = 0 to 65535
 Restriction None

:STATus:OPERation:ENABle <Numeric>

Function Sets the operation register enable data.
 Parameter Register = 0 to 65535
 Restriction None

:STATus:OPERation:ENABle?

Function Reads out the operation register enable data.
 Response Register = 0 to 65535
 Restriction None

SECTION 6 GPIB

:STATus:OPERation:PTRansition?

Function	Reads out the operation register transition filter (positive).
Response	Always 65535
Restriction	None

:STATus:OPERation:NTRansition?

Function	Reads out the operation register transition filter (negative).
Response	Always 0
Restriction	None

6.8 IEEE488.2 Common Command

*IDN?	Identification Query
Function	Reads out the manufacturer name, model number etc. of the product.
Response	ANRITSU, MG3641A, 0, 1 or ANRITSU, MG3642A, 0, 1
*OPC	Operation Complete Command
Function	Set the bit-0 digit in the standard event status register when all the pending selected-device operations have been completed.
Parameter	None
*OPC?	Operation Complete Query
Function	Sets 1 in the output queue to generate a MAV summary message when all the pending selected-device operations have been completed.
Response	1
*TST?	Self-test Query
Function	Executes a self-test and returns the results of any errors.
Response	Result = 0 : Indicates that the self-test completed without errors. 1 : Indicates that the self-test is not completed, or is completed with errors.
*WAI	Wait-to-continue Command
Function	Keeps the next command on stand-by state while the device is executing a command.
Parameter	None
*CLS	Clear Status Command
Function	Clear the status byte register.
Parameter	None
*ESE	Standard Event Status Enable Command
Function	Sets or clear the standard event status enable register.
Parameter	Register = 0 to 255
*ESE?	Standard Event Status Enable Query
Function	Reads out the standard event status enable register.
Response	Register = 0 to 255
*ESR?	Standard Event Status Register Query
Function	Reads out the current value in the standard event status register.
Response	Register = 0 to 255
*SRE	Service Request Enable Command
Function	Sets the bits in the service request enable register.
Parameter	Register = 0 to 255
*SRE?	Service Request Enable Query
Function	Reads out the service request enable register.
Response	Register = 0 to 255

SECTION 6 GPIB

*STB?	Read Status Byte Query
Function	Reads out the current value of the status byte including the MSS bit.
Response	Register = 0 to 255
*PSC <Numeric>	Power On Status Clear Command
Function	Determines whether the service request, enable register, standard event status, and parallel poll enable register are cleared or not at power-on.
Parameter	<Numeric> = 0 : Not cleared 1 : Cleared
*PSC?	Power On Status Clear Query
Function	Queries whether the power-on-status-clear flag is TRUE or FALSE.
Response	Power-on-status-clear flag = 0 : FALSE 1 : TRUE
*SAV <Numeric>	Save Command
Function	Saves to the memories.
Parameter	<Numeric> = 0 to 999
	*This command is the same as “:MEMory:STORE”.
*RCL <Numeric>	Recall Command
Function	Recalls from memories.
Parameter	<Numeric> = 0 to 999
	*This command is the same as “:MEMory:RECall”.
*RST	Reset Command
Function	Resets the device in the third level.
Parameter	None

6.9 Sample Program

This section explains how to write a program for controlling the MG3641A/MG3642A and MS2651A spectrum analyzer on the configuration below in the N88-BASIC language of the NEC PC9800 personal computer.

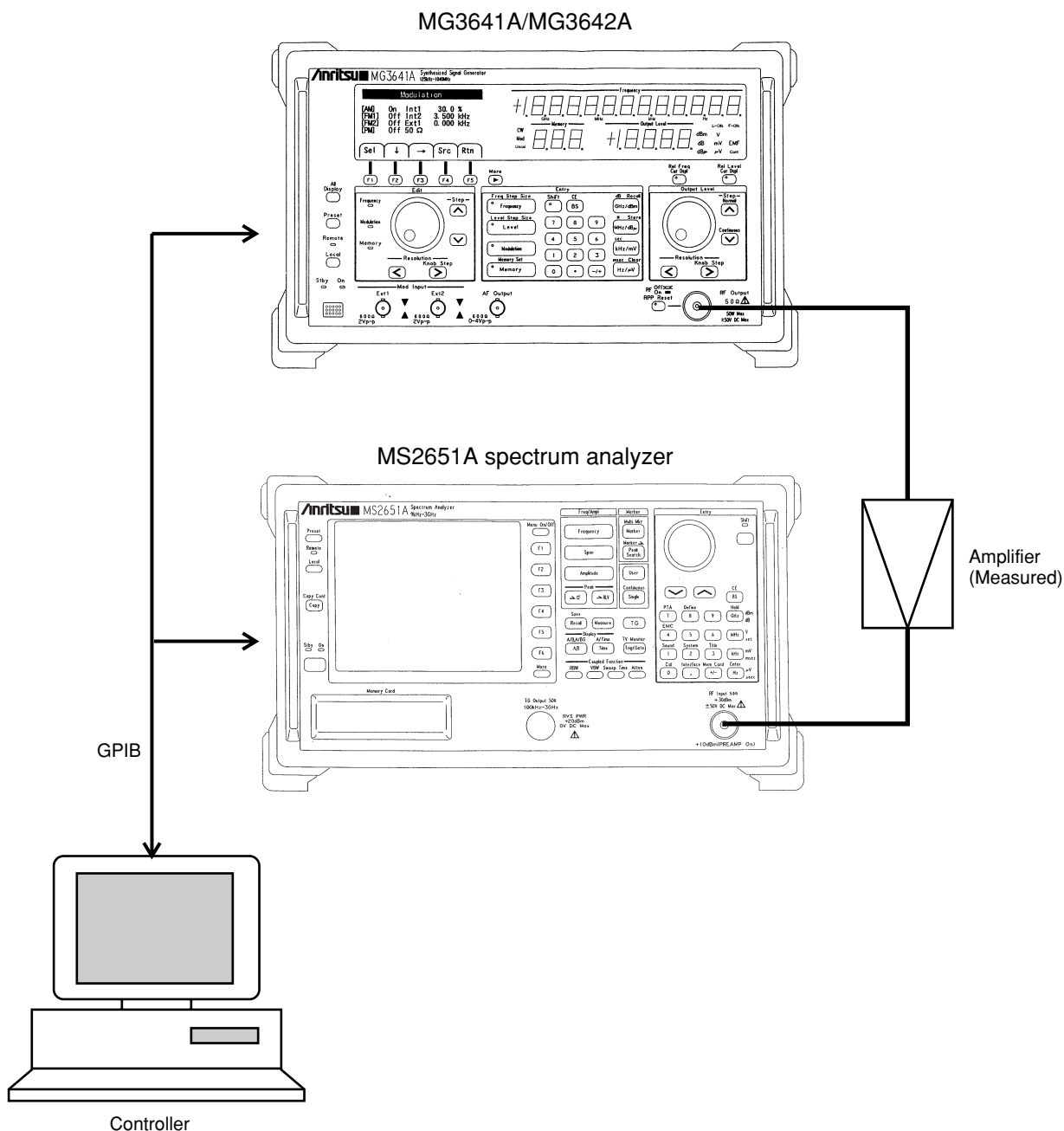

Generate a program that varies the MG3641A/MG3642A output level every 2 dB step in the range from -30 dBm to 0 dBm according to the input of the amplifier and measures the output level of the amplifier with the MS2651A spectrum analyzer in this connection state.

SECTION 6 GPIB

```

100 ' *****
110 ' *
120 ' * INPUT vs OUTPUT characteristic of amplifier *
130 ' * measurement program *
140 ' *
150 ' *****
160 '
170 ' ***** initialize GPIB system *****
180 '
190 ISET IFC' ..... Sends interface clear
200 ISET REN' ..... Makes remote enable true
210 CMD DELIM=2' ..... Sets the delimiter to LF
220 CMD TIMEOUT=5' ..... Sets the time-out parameter to 5 sec.
230 '
240 ' ***** input measurement parameter *****
250 '
260 INPUT "MEASUREMENT FREQUENCY (MHz)";MF
270 '
280 ' ***** setting the MG3641A/MG3642A *****
290 '
300 PRINT @3; "*RST" ' ..... Initializes the MG3641A/MG3642A
310 PRINT @3; ".FREQ"+STR$(MF)+"MHz" ' ..... Sets a frequency
320 PRINT @3; ".AMPL:STAT OFF" ' ..... Turns off the output
330 '
340 ' ***** setting the MS2651A *****
350 '
360 PRINT @1; "INI" ' ..... Initializes the MS2651A
370 PRINT @1; "SP 100KHZ" ' ..... Sets the frequency span to 100 kHz
380 PRINT @1; "CF"+STR$(MF)+"MHZ" ' ..... Sets a center frequency
390 PRINT @1; "RL 20DBM" ' ..... Sets the reference level to 20 dBm
400 '
410 ' ***** measurement *****
420 '
430 PRINT "INPUT OUTPUT GAIN"
440 PRINT @3; ".AMPL:STAT ON" ' ..... Turns on the output
450 FOR LEVEL1 = -30 TO 0 STEP 2
460 PRINT @3; ".AMPL:LEV"+STR$(LEVEL1)+"dBm" ' ..... Sets the output level
470 FOR TIMER = 0 TO 1000:NEXT TIMER
480 PRINT @1; "TS;MKPK" ' ..... Sweeps once and searches for a peak
490 PRINT @1; "MKL?" ' ..... Issues a marker level reading data request
500 INPUT @1;LEVEL2
510 PRINT USING "###.dBm ###.dBm ###.dB";LEVEL1,LEVEL2,LEVEL2-LEVEL1
520 NEXT LEVEL1
530 '
540 END

```

Execution samples

INPUT	OUTPUT	GAIN
-30.0 dBm	-5.2 dBm	24.8 dB
-28.0 dBm	-3.2 dBm	24.8 dB
-26.0 dBm	-1.2 dBm	24.8 dB
-24.0 dBm	.8 dBm	24.8 dB
-22.0 dBm	2.8 dBm	24.8 dB
-20.0 dBm	4.8 dBm	24.8 dB
-18.0 dBm	6.8 dBm	24.8 dB
-16.0 dBm	8.8 dBm	24.8 dB
-14.0 dBm	10.8 dBm	24.8 dB
-12.0 dBm	12.5 dBm	24.5 dB
-10.0 dBm	13.0 dBm	23.0 dB
-8.0 dBm	13.2 dBm	21.2 dB
-6.0 dBm	13.3 dBm	19.3 dB
-4.0 dBm	13.3 dBm	17.3 dB
-2.0 dBm	13.3 dBm	15.3 dB
.0 dBm	13.3 dBm	13.3 dB

6.10 GPIB Command Interchange Function

6.10.1 Outline

The MG3641A/MG3642A provides a GPIB command interchange mode so that it can be operated with the automatic measurement software written for Anritsu's MG3631A/32A or MG3633A.

When using the GPIB command interchange function, set the following items before hand:

- (1) Press the "GPIB" [F2] key on the Main Menu (2) to open the "GPIB" menu.

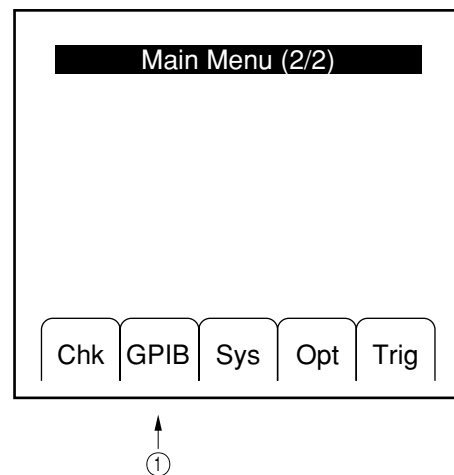

- (2) Press the "↓" [F2] key or "↑" [F3] key to select "Command" (the status display is high lighted).
- (3) Use the "Sel" [F1] key to select the device to be interchanged.
 - Usual mode: SCPI
 - MG3633A interchange: MG3633A
 - MG3631A/32A interchange: MG3631A/32A

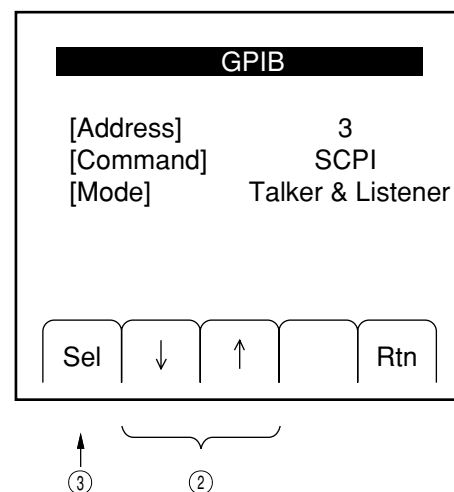

Not all MG3641A/MG3642A functions can be controlled in command interchange mode. To program the new automatic measurement software, use the normal "SCPI" command.

Even if command interchange mode is used, complete interchangeability cannot be obtained because the hardware configuration is different from that of the interchange object device. Paragraphs 6.10.2 and 6.10.3 describe the restrictions in command interchange mode. The contents of these paragraphs must be understood before using command interchange mode.

6.10.2 Restrictions in MG3633A command interchange mode

This paragraph describes the restrictions in MG3633A command interchange mode.

(1) Common items

- Exponent representation of numeric data is unavailable.
- The semicolon (;) is the only valid separator when multiple commands are sent on one line. Do not use the comma (,).
- No header is added to talker data for a query command. Only numeric data is output.

(2) Frequency

- Frequency up and down (TFR and EFR) using the rotary knob are enabled by substituting the step key function. Using the step key and rotary knob to increase or decrease the frequency may not perform correctly unless a frequency step value (FIS<Numeric><Freq term>) or frequency resolution (R0 to R9) is set.
- Resetting the frequency (ZFR) cannot be interchanged because the MG3641A/MG3642A does not have an equivalent function.
- The frequency offset display function can be interchanged only with the multistatement description (FOS<Numeric><Freq term>;SP12) of the offset frequency setting command (FOS<Numeric><Freq term>) and offset display mode ON command (SP12) separated by a semicolon (;).

(3) Output level

- Output level up and down (TOL and EOL) using the rotary knob are enabled by substituting the step key function. Using the step key and rotary knob to increase or decrease the level may not perform correctly unless the level step value (OIS<Numeric><Ampl term>) or level resolution digits (L0 to L2) are set.
- The level resetting function (ZOL) cannot be interchanged because the MG3641A/MG3642A does not have an equivalent function.
- The level offset display function can be interchanged only with the multistatement description (OOS<Numeric><Ampl term>;SP08) of the offset level setting command (OOS<Numeric><Ampl term>) and offset display mode ON command (SP08) separated by a semicolon (;).
- If the output level setting (OL<Numeric><Ampl term>) or level step up or down (UOL, DOL) command is executed in level continuous mode, the continuous mode is canceled.
- The command relating to the output level limiter (OLM<Numeric><Ampl term>, SP05, SP06) cannot be interchanged because the MG3641A/3642A does not have an equivalent function.

(4) AM modulation

- AM modulation cannot be turned on by the AM modulation setting command (AM<Numeric><AM term>).
- Because AM modulation up and down (TEM and EAM) using the rotary knob are enabled by substituting the step key function, the AM modulation resolution is fixed to ten percent.
- Only 1 kHz (M1) and 400 Hz (M2) can be selected as the modulation signal source when INT AM is executed. AF (M0) cannot be selected.
- The Ext1 connector of Mod Input is assigned as the external modulation input of AM modulation.
- INT and EXT cannot be modulated together (A4 and A5).

(5) FM modulation

- FM modulation cannot be turned on using the FM deviation setting command (FM<Numeric><Freq term>).
- Even if INT FM deviation fixing (IND<Numeric><Freq term>) or EXT FM deviation fixing (EXD<Numeric><Freq term>) is executed, when FM deviation is set (FM<Numeric><Freq term>), both INT FM deviation and EXT FM deviation become the same FM deviation.
- When FM deviation is stepped up or down (UFM or DFM), the deviation changing amount of the MG3641A/ MG3642A becomes $\times 2, \div 2$ as against $\times 10, \div 10$ for the MG3633A.
- Because FM deviation up and down (TFM and EFM) using the rotary knob are enabled by substituting the step key function, the resolution cannot be selected. The rotary knob operates in the same manner as the step key.
- Only 1 kHz (M1) or 400 Hz (M2) can be selected as the modulation signal source when INT FM is executed. AS (M0) cannot be selected.
- The Ext2 connector of Mod Input is assigned as the external modulation input of FM modulation.
- The modulation signal polarity cannot be switched (SP23 or SP24).

(6) Modulation signal source

- Only 400 Hz (M2) and 1 kHz (M1) can be selected as the internal modulation signal source. The signal source corresponding to AF (M0) cannot be selected.
- Only AF frequency setting using the numeric data (AF<Numeric><Freq term>) is valid. The AF frequency cannot be set by stepping up or down (UAF or DAF) or by using the rotary knob (TAF or EAF).
- The INIT MOD DC application functions (SP30 to SP33) cannot be interchanged because the MG3641A/ MG3642A does not have an equivalent function.

(7) Sweep

- Because the sweep marker of the MG3641A/MG3642A is always on, the sweep marker ON/OFF switching commands (SF4, SO4, SF5, and SO5) are invalid.
- Stepping up (SF8 and SO8) and down (SF9 and SO9) cannot be done during manual sweep.
- The sweep start point presets (SFA and SOA) and stop point presets (SFB and SOB) cannot be interchanged because the MG3641A/MG3642A does not have an equivalent function.
- The AF frequency sweep cannot be executed because the MG3641A/MG3642A does not have this function.
- The memory sweep function cannot be interchanged because sweep parameters and memory are managed completely differently.

(8) Memory

- Because the MG3641A/MG3642A does not have a frequency memory, the command relating to the frequency memory (FQ) cannot be interchanged.

(9) Other non-interchangeable functions

- Commands relating to phase modulation cannot be interchanged because the MG3641A/MG3642A does not have a phase modulation function.
- The trigger program editing function cannot be interchanged because the trigger program is constructed differently.
- Functions relating to SRQ are not interchangeable.

6.10.3 Restrictions in MG3631A/32A command interchange mode

This paragraph describes the restrictions in MG3631A/32A command interchange mode.

- (1) Common items
 - Exponent representation of numeric data is unavailable.
 - The semicolon (;) is the only valid separator when multiple commands are sent on one line. Do not use the comma (,).

- (2) Frequency
 - Frequency up and down (FU and FD) using the rotary knob are enabled by substituting the step key function. Using the step key and rotary knob to increase or decrease the frequency may not perform correctly unless the frequency step value (DF<Numeric><Freq term>) or frequency resolution digits (R1 to R7) are set.

- (3) Output level
 - Output level up and down (LU and LD) using the rotary knob are enabled by substituting the step key function. Using the step key and rotary knob to increase and decrease the level may not perform correctly unless the step value (DL<Numeric><Ampl term>) or level resolution digits (L2 to L4) are set.
 - If output level setting (OL<Numeric><Amp term>) or stepping up or down (FU or FD) is executed in level continuous mode, the continuous mode is canceled.

- (4) AM modulation
 - Only AM modulation settings using numeric data (AM<Numeric><AM term>) are valid. Stepping up or down (MU or MD) cannot be used.
 - Because the MG3641A/MG3642A has only one system of AM modulation, AM MIX SOURCE cannot be used.
 - The Ext1 connector of Mod Input is assigned as the external modulation input.

- (5) FM modulation
 - Only FM deviation settings using numeric data (FM<Numeric><Freq term> or FM<numeric><Freq term>) are valid. Stepping up or down (MU or MD) cannot be used.
 - The Ext1 connector of Mod Input is assigned as the external modulation input.

(6) Modulation signal source

- Only AF frequency settings using numeric data (AF<Numeric><Freq term>) are valid. Stepping up or down (AIU or AID) and the rotary knob (AU or AD) cannot be used.
- The modulation signal polarity cannot be switched (EXN or EXI).

(7) Memory

- Memory skip setting (FN<Numeric>SK) cannot be interchanged because the setting address units are different.

(Blank)

SECTION 7

PERFORMANCE TEST

7.1 Performance Test Required

The performance test is performed as the preventive maintenance to prevent the MG3641A/MG3642A performance from reducing.

The performance test is required when performance must be confirmed after the MG3641A/MG3642A acceptance test, periodical inspection, or repair. For important items, it should periodically be performed as the preventive maintenance.

If an item that does not satisfy the standard by the performance test is detected, contact the Anritsu service division.

7.2 Performance Test Device List

Table 7-1 lists the measuring instruments for calibration according to the test parameters.

Table 7-1. Performance Test Device List

Test parameter	Measuring instrument	Requested performance*	Recommended device
Output frequency	Frequency counter	100 kHz to 2.08 GHz	MF1603A
Output level frequency characteristics	Power meter	100 kHz to 2.08 GHz -30 to +20 dBm	ML4803A MA4601A
Output level accuracy	Spectrum Analyzer Pre-amplifier	100 kHz to 2.08 GHz 100 kHz to 2.08 GHz 40 dB	MS2602A
FM frequency deviation AM modulation factor	Modulation analyzer	100 kHz to 2.08 GHz AM, FM	MS616B
Modulation distortion	Distortion meter	20 Hz to 100 kHz	

* Extracts a part of performance that can cover the test parameter measurement range.

7.3 Performance Test

To confirm performance after the MG3641A/MG3642A acceptance test, periodical inspection, or repair, check the following items for performance test:

- Output frequency
- Output level frequency characteristics
- Output level accuracy
- FM deviation, FM distortion
- AM modulation factor, AM distortion

The performance test is executed according to the ordinary use state; therefore, the user need not adjust the inside of the device like the calibration. For important items, the performance test should be performed periodically for preventive maintenance.

Use the performance test result sheet in Appendix E to record the test results.

CAUTION

For performance test, the tested unit and measuring instruments must sufficiently be preheated for at least 30 minutes to make them stable. To obtain the highest measurement accuracy, the performance test must be executed at room temperature or lower; the AC power voltage varies a little only; there must be no abnormal noise, vibration, dust, or humidity.

SECTION 7 PERFORMANCE TEST

7.3.1 Output frequency

Confirm that the set frequency is output correctly.

- (1) Test specifications
 - Frequency range 125 kHz to 1040 MHz (MG3641A)
125 kHz to 2080 MHz (MG3642A)
 - Set resolution 0.01 Hz
- (2) Measuring instrument for test
 - Frequency counter
- (3) Setup

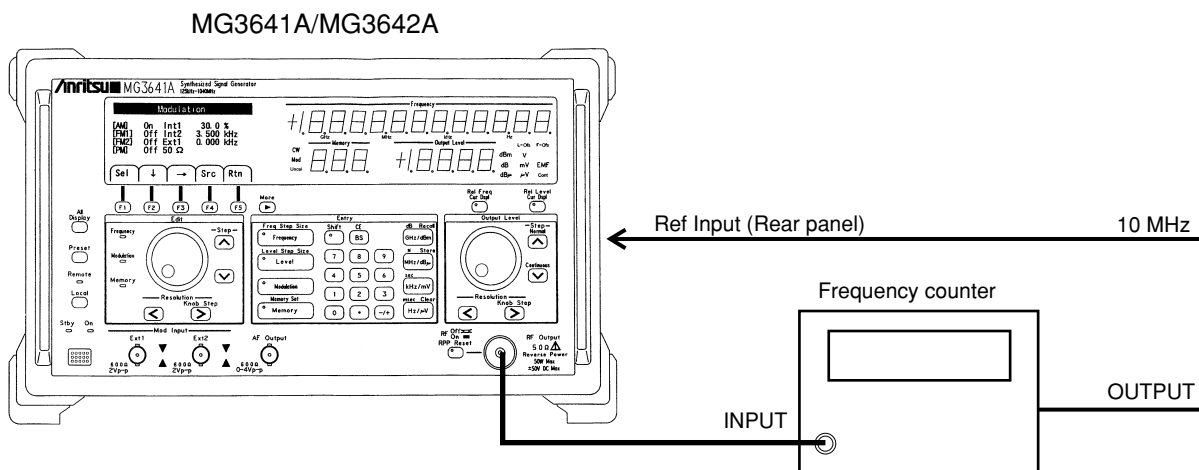

Fig. 7-1. Output Frequency Test

(4) Test procedure

STEP	PROCEDURE
1.	Connect the reference frequency output (10 MHz) of the frequency counter to the MG3641A/MG3642A external reference input (Ref Input).
2.	Connect the MG3641A/MG3642A output to the input of the frequency counter. (See Figure 7-1.)
3.	Set the MG3641A/MG3642A output level to +7 dBm.
4.	Set the MG3641A/MG3642A frequency to an arbitrary value.
5.	Confirm that the indicator of the frequency counter is equal to the set value.
6.	Change the frequency and repeat this measurement procedure.

(5) Note on test

The indicator of the frequency counter may include a ± 1 count error.

7.3.2 Output level frequency characteristics

- (1) Test specifications
 - Frequency characteristics with reference to 0 dBm
 ± 0.5 dB
- (2) Measuring instrument for test
 - Power meter (100 kHz to 2080 MHz)
- (3) Setup

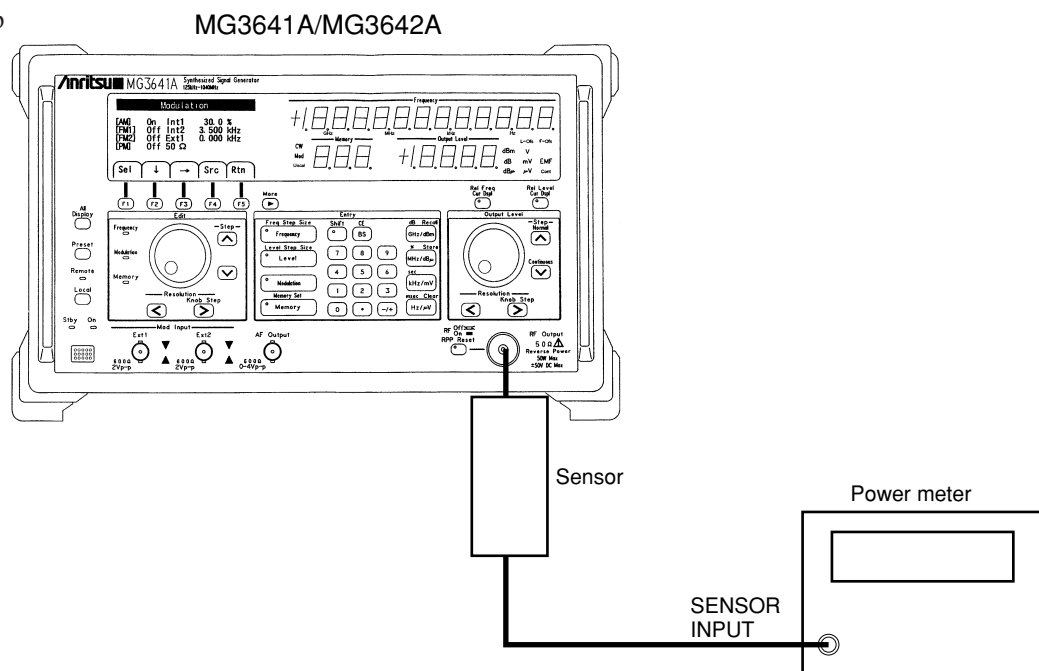

Fig. 7-2. Output Level Frequency Characteristic Test

- (4) Test procedure

STEP	PROCEDURE
1.	Adjust the power meter to the zero point and correct the sensor sensitivity.
2.	Set the MG3641A/MG3642A output level to 0 dBm.
3.	Set the MG3641A/MG3642A to the frequency to be measured.
4.	Set the calibration factor of the sensor of the power meter and read the output level.
5.	Repeat steps 3 and 4.

- (5) Note on test

The MG3641A/MG3642A output level is defined with the RF output connector. To measure the output level, directly connect the power sensor to the MG3641A/MG3642A RF output connector.

7.3.3 Output level accuracy

- (1) Test specifications
 - Output level accuracy ± 1 dB ($\leq +17$ dBm, ≥ -127 dBm)
 - ± 3 dB (< -127 dBm)
- (2) Measuring instrument for test
 - MS2602A Spectrum analyzer (100 kHz to 2080 MHz)
 - Pre-amplifier (100 kHz to 2080 MHz, gain 40 dB, noise figure ≤ 10 dB)
 - Fixed attenuator (100 kHz to 2080 MHz, attenuation 3 dB)
- (3) Setup

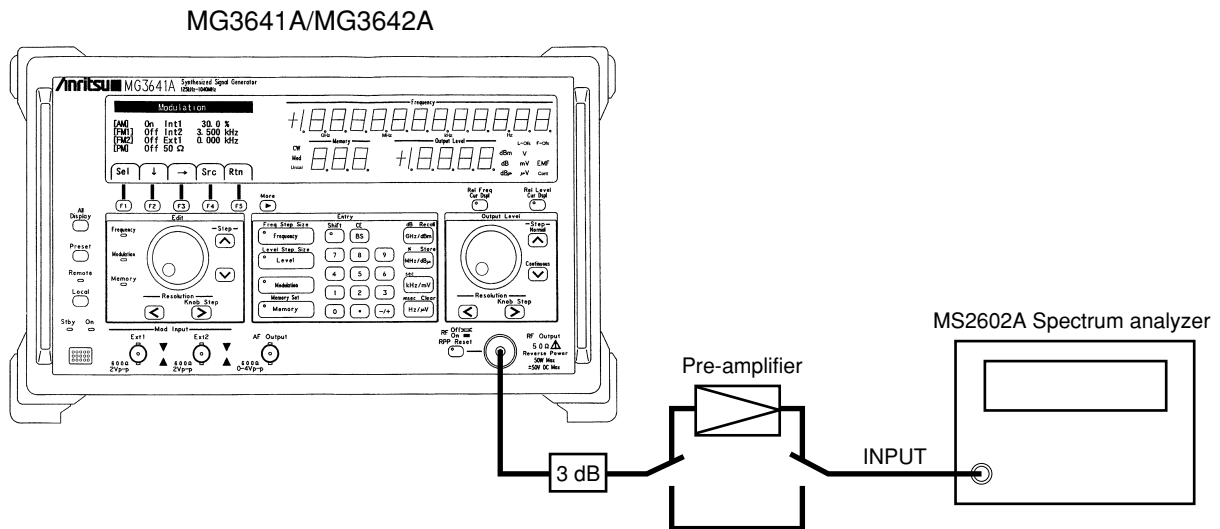

Fig. 7-3 Output Level Accuracy Test

- (4) Test procedure (For test, use the calculation sheet of the performance test result sheet in Appendix E.)

STEP	PROCEDURE
1.	Execute the internal calibration (ALL CAL) of the MS2602A.
2.	Set the MG3641A/MG3642A frequency to the measurement frequency, and the level to +17 dBm. Here, do not use the pre-amplifier.
3.	Set the MS2602A to time-domain sweep mode, reference level +22 dBm, RF attenuator 45 dB, RBW 10 Hz, VBW 10 Hz, and sweep time 50 ms. Fine-adjust the center frequency around the measuring frequency to maximize the marker level.
4.	Record the marker level displayed. (Ma_{+17})
5.	Set the MG3641A/MG3642A output level to +16 dBm, and the MS2602A reference level to +21 dBm. Record the marker level displayed. (Ma_{+16})
6.	Setting the MG3641A/MG3642A output level down to -8 dBm, repeat the measurement and record the marker level displayed. (Ma_{+15} to Ma_{-8})

STEP	PROCEDURE
7.	Set the MS2602A RF attenuator to 25 dB with the same setup as in STEP 6.
8.	Record the marker level displayed. (Mb ₈)
9.	Setting the MG3641A/MG3642A output level down to -28 dBm, repeat the measurement and record the marker level displayed. (Mb ₁₃ to Mb ₂₈) Where, always set the MS2602A reference level to the larger level by 5 dB than the MG3641A/MG3642A output level.
10.	Set the MS2602A RF attenuator to 5 dB with the same setup as in STEP 9.
11.	Record the marker level displayed. (Mc ₂₈)
12.	Setting the MG3641A/MG3642A output level down to -48 dBm, repeat the measurement and record the marker level displayed. (Mc ₃₃ to Mc ₄₈) Where, always set the MS2602A reference level to the larger level by 5 dB than the MG3641A/MG3642A output level.
13.	Set the MS2602A RF attenuator to 25 dB and reference level to -3 dBm, and set the pre-amplifier as shown in Fig.7-3.
14.	Record the marker level displayed. (Md ₄₈)
15.	Setting the MG3641A/MG3642A output level down to -68 dBm, repeat the measurement and record the marker level displayed. (Md ₅₃ to Md ₆₈) Where, always set the MS2602A reference level to the larger level by 45 dB than the MG3641A/MG3642A output level.
16.	Set the MS2602A RF attenuator to 5 dB with the same setup as in STEP 15.
17.	Record the marker level displayed. (Me ₆₈)
18.	Setting the MG3641A/MG3642A output level down to -143 dBm, repeat the measurement and record the marker level displayed. (Me ₇₃ to Me ₁₄₃) Where, always set the MS2602A reference level to the larger level by 45 dB than the MG3641A/MG3642A output level. However, at -143 dBm measurement, set the MS2602A reference level to -93 dBm. At ≤ -118 dBm measurement, perform the measurement with video averaging(10 times) to improve S/N.
19.	Calculate the output level accuracy using the calculation sheet in Appendix E.

(5) Note on test

Above mentioned method uses the settings which minimize the internal error of the MS2602A. So, if any other spectrum analyzer is used, the measurement accuracy cannot be expected.

On some measurement frequencies, the test may not be performed with enough accuracy because of the internal residual response and an external noise. In this case, shift the measurement frequency.

Since above mentioned method uses the very narrow RBW of the MS2602A, the frequency error occurs if the frequency drifts. So, heat run the MG3641A/MG3642A and the MS2602A.

7.3.4 FM deviation and FM distortion

(1) Test specifications

- Range

0 to 125 Hz	(≥ 125 kHz, <250 kHz)
0 to 250 Hz	(≥ 250 kHz, <500 kHz)
0 to 500 Hz	(≥ 500 kHz, <1 MHz)
0 to 1 kHz	(≥ 1 MHz, <2 MHz)
0 to 2 kHz	(≥ 2 MHz, <4 MHz)
0 to 4 kHz	(≥ 4 MHz, <8 MHz)
0 to 10 kHz	(≥ 8 MHz, <16 MHz)
0 to 25.6 kHz	(≥ 16 MHz, <32 MHz)
0 to 51.2 kHz	(≥ 32 MHz, <64 MHz)
0 to 102 kHz	(≥ 64 MHz, <128 MHz)
0 to 256 kHz	(≥ 128 MHz, <256 MHz)
0 to 512 kHz	(≥ 256 MHz, <512 MHz)
0 to 1024 kHz	(≥ 512 MHz, ≤ 1040 MHz)
0 to 2048 kHz	(>1040 MHz, MG3642A only)

- Accuracy

with reference to Source=Int1 1 kHz, and in a 300 Hz to 3 kHz demodulation band:

 - $\pm (5\% \text{ of set value} + 10 \text{ Hz})$ (≥ 0.4 MHz, <512 MHz)
 - $\pm (5\% \text{ of set value} + 20 \text{ Hz})$ (≥ 512 MHz, ≤ 1040 MHz)
 - $\pm (5\% \text{ of set value} + 40 \text{ Hz})$ (>1040 MHz, MG3642A)

- Distortion

with reference to ≥ 16 MHz, and Source=Int1 1 kHz

 - <-40 dB (FM=3.5 kHz deviation)
 - <-45 dB (FM=22.5 kHz deviation)

(2) Measuring instrument for test

- Modulation analyzer
- Distortion meter

(3) Setup

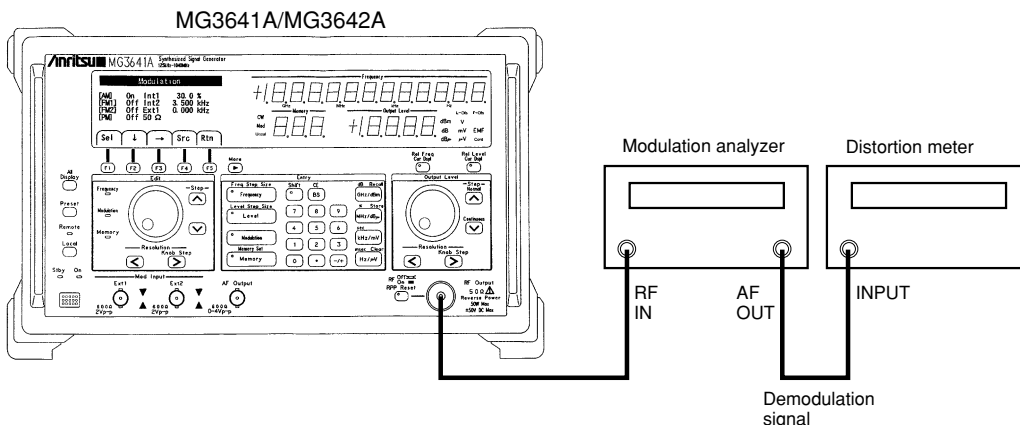

Fig. 7-4. FM Deviation and FM Distortion

(4) Test procedure

STEP	PROCEDURE
<u>FM deviation</u>	
1.	Set the MG3641A/MG3642A output level to +7 dBm.
2.	Set the MG3641A/MG3642A frequency and modulation analyzer receive frequency to the expected frequency.
3.	Turn on the MG3641A/MG3642A FM, and set Source to Int1 1 kHz.
4.	Set the MG3641A/MG3642A FM frequency deviation.
5.	Read the indicator of the modulation analyzer.
6.	Change the MG3641A/MG3642A FM frequency deviation and repeat the measurement.
<u>FM distortion</u>	
7.	Set the MG3641A/MG3642A FM frequency deviation to 3.5 kHz or 22.5 kHz.
8.	Measure the demodulation output of the modulation analyzer using the distortion meter.

(5) Note on test

- The demodulation zone of the modulation analyzer must be within 0.3 to 3 kHz at measurement of the FM deviation and 0.3 to 15 kHz or 0.3 to 20 kHz at measurement of distortion rate.
- Using a modulation analyzer with much residual FM affects the measurement of distortion if the FM deviation rate is lower. Use a modulation analyzer with a little residual FM.

7.3.5 AM modulation factor and AM distortion

(1) Test specifications

- Range 0 to 100 %
- Accuracy with reference to ≥ 0.4 MHz, $\leq +7$ dBm, AM ≤ 90 %, Source=Int1 1 kHz, and in a 300 Hz to 3 kHz demodulation band: $\pm (5\% \text{ of set value} + 2\%)$
- Distortion with reference to ≥ 0.4 MHz, $\leq +7$ dBm, Source=Int1 1 kHz:
 - < -40 dB (AM=30 %)
 - < -30 dB (AM=90 %)

(2) Measuring instrument for test

- Modulation analyzer
- Distortion meter

(3) Setup

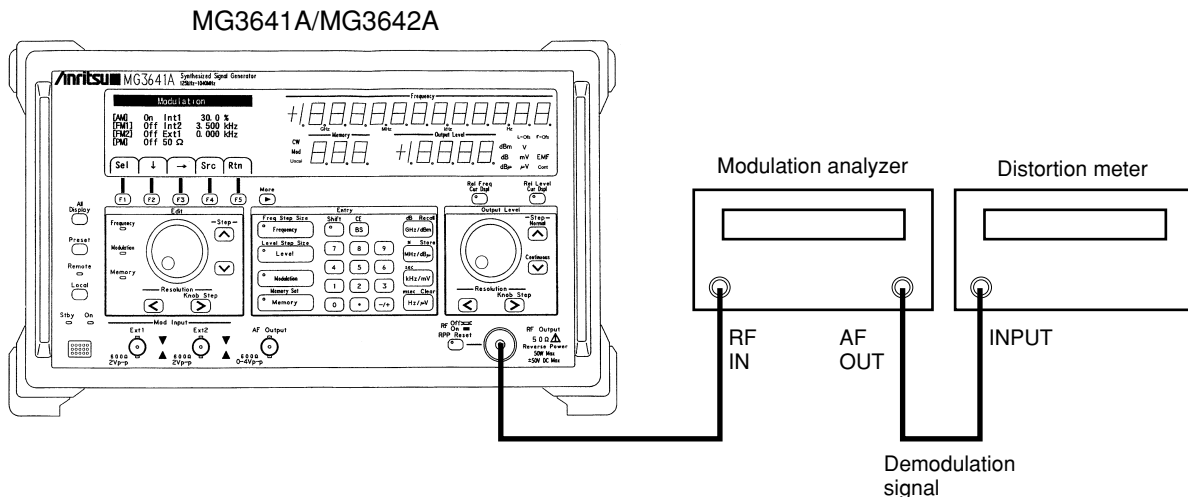

Fig. 7-5. AM modulation factor and AM Distortion Test

(4) Test procedure

STEP	PROCEDURE
AM modulation factor	
1.	Set the MG3641A/MG3642A output level to +7 dBm.
2.	Set the MG3641A/MG3642A frequency and modulation analyzer receive frequency to the expected frequency.
3.	Turn on the MG3641A/MG3642A AM, and set Source to Int1 1 kHz.
4.	Set the MG3641A/MG3642A AM modulation factor.
5.	Read the indicator of the modulation analyzer.
6.	Change the MG3641A/MG3642A AM modulation factor and repeat the measurement.
AM distortion	
7.	Set the MG3641A/MG3642A AM modulation to 30 % and 90 %.
8.	Measure the demodulation output of the modulation analyzer with the distortion meter.

(5) Note on test

The demodulation zone of the modulation analyzer must be within 0.3 to 3 kHz at measurement of the modulation factor and 0.3 to 15 kHz or 0.3 to 20 kHz at measurement of the distortion.

SECTION 7 PERFORMANCE TEST

(Blank)

SECTION 8 CALIBRATION

8.1 Calibration Required

The calibration is performed as the preventive maintenance to prevent the MG3641A/MG3642A performance from reducing.

The calibration is required when the inside of this device need periodically be adjusted to maintain the MG3641A/MG3642A performance even if the MG3641A/MG3642A itself operates normally.

If an item that does not satisfy the calibration standard is detected, contact out service division.

8.2 Calibration Device List

Table 8-1 lists the calibration devices according to the calibration items.

Table 8-1. Calibration Device List

Calibration item	Measuring instrument	Requested performance*	Recommended device
Reference oscillator frequency accuracy	Oscilloscope	10 MHz measurable External trigger possible	
Reference oscillator frequency accuracy	Frequency standard	Standard radio wave receiver or equivalent (Accuracy: 1×10^{-9} order or more)	

* Extracts a part of performance that can cover the calibration item measurement range.

8.3 Calibration

For the MG3641A/MG3642A, calibrate the frequency of the built-in Reference oscillator once a half year.

The stability of the MG3641A/MG3642A 10 MHz reference crystal oscillator is $\pm 5 \times 10^{-9}$ per day. Therefore, as the frequency standard, use a standard signal generator that receives the typical radio wave and subcarrier of the color telecasting (signal locked to the rubidium atomic standard) and issues a signal locked to it.

(1) Calibration specifications

- Reference oscillator (standard)
 - Frequency 10 MHz
 - Aging rate $\pm 5 \times 10^{-9}$ /day
 - Activation characteristics 1×10^{-7} /10 min. (reference after 24 hour operation)
 - Temperature characteristics $\pm 3 \times 10^{-8}$ (0 to 50°C)
- Reference oscillator (Opt 01)
 - Frequency 10 MHz
 - Aging rate 5×10^{-10} /day
 - Temperature characteristics $\pm 5 \times 10^{-9}$ (0 to 50°C)

(2) Measuring instruments for calibration

- Oscilloscope
- Frequency standard

(3) Setup

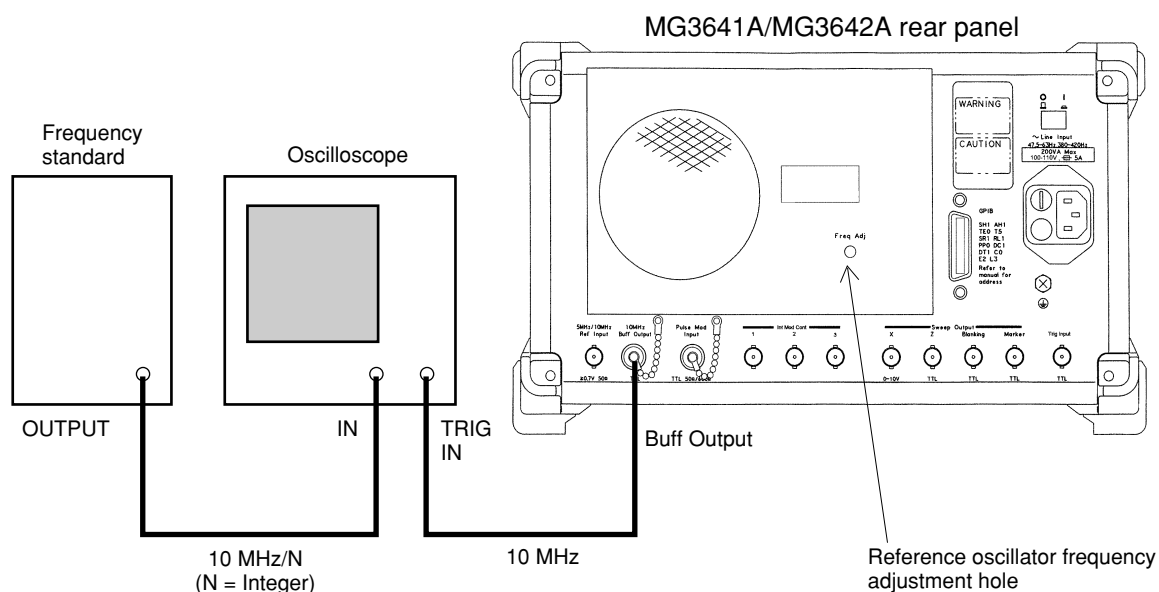

Fig. 8-1. Calibration of Reference Oscillator

(4) Calibration procedure

STEP	PROCEDURE
1.	Setup the device at room temperature $23 \pm 5^\circ\text{C}$. See Figure 8-1.
2.	Set the \bigcirc switch on the rear panel to ON to preheat the MG3641A/MG3642A Reference oscillator and hold this state for 24 hours.
3.	After 24 hours lapsed, set the Stby/On switch on the front panel to ON.
4.	Apply the standard frequency to the external synchronization input of the oscilloscope. Also apply the output signal of the buffer output connector on the rear of the MG3641A/MG3642A to vertical axis Y of the oscilloscope.
5.	Adjust the oscilloscope so that the input waveform can be observed. If the input waveform on the oscilloscope moves to the right or left and the synchronization is difficult, the frequency of the Reference oscillator does not match the standard.
6.	The MG3641A/MG3642A is provided a Reference oscillator calibration hole on the rear. See Figure 8-1. Turn the potentiometer in the hole so that the input waveform on the oscilloscope does not move to the right or left.

Note : If standard frequency 10 MHz is applied to axis X of the oscilloscope, a Lissajous's waveform is generated. In this case, adjust the frequency of the Reference oscillator in step 6 so that a static circle is drawn.

SECTION 8 CALIBRATION

(Blank)

SECTION 9

STORAGE AND TRANSPORTATION

This section describes daily maintenance, storage, and transportation of the MG3641A/MG3642A.

9.1 Daily Servicing and Preventive Maintenance

To prevent degradation of the performance of the MG3641A/MG3642A, the MG3641A/MG3642A should be operated correctly under the specified conditions. Calibration and performance tests should also be performed routinely. The regular servicing method and interval are shown in Table 9-1.

Table 9-1. Regular Servicing

	Period	Method
Soiling	<ul style="list-style-type: none"> • Before long-term storage • When used in dusty locations • When noticeable dust and dirt have accumulated inside cabinet 	Wipe with damp cloth and soapy water or cleaning solvent if proper ventilation is provided.* (DAIFLON)
Dust		Open cabinet and blow out dust with compressed air, taking care to shield face from dust or loose particles.
Lubrication	None	
Loose screws	When detected	Retighten with recommended tool

* Do not use acetone or benzene; the paint finish may be damaged.

9.2 Storage Precautions

This paragraph describes the precautions to take when storing the MG3641A/MG3642A for a long time.

9.2.1 Precautions before storage

1. Wipe any dust and fingermarks off the cabinet.
2. Check the performance to confirm that the MG3641A/MG3642A operates normally.
3. The maximum and minimum storage temperature range is 60° to -20 °C. The maximum humidity is 90 %.
4. Avoid storing it in locations where it may be exposed to direct sunlight, condensation (more than 90 %), excessive dust, or active gases.

SECTION 9 STORAGE AND TRANSPORTATION

9.2.2 Recommended storage conditions

In addition to meeting the conditions listed in paragraph 6.2.1, the MG3641A/MG3642A should preferably be stored where:

1. Temperature is 0° to 30°C
2. Humidity is 40 % to 80 %
3. Temperature and humidity are stable

Before using the MG3641A/MG3642A after storage, check the performance.

9.3 Repacking and Transportation

When transporting the MG3641A/MG3642A over long distances, observe the precautions described below.

9.3.1 Repacking

Use the original packing materials. If the original packing materials were thrown away or destroyed, repack the MG3641A/MG3642A as follows:

1. Install the protective covers over the front and rear panels.
2. Wrap the MG3641A/MG3642A in plastic or similar material.
3. Obtain a cardboard, wood, or aluminum box 10 to 15 cm larger than the MG3641A/MG3642A on all sides.
4. Put the MG3641A/MG3642A in the center of the box and fill the surrounding space with shock absorbent material.
5. Secure the box with twine, tape, or bands.

Note : It is easy to repack the MG3641A/MG3642A if the original packing materials are saved.

9.3.2 Transportation

Transport the MG3641A/MG3642A under the storage conditions recommended in paragraph 9.2.2.

APPENDIX A

INITIAL FACTORY SETTINGS

Set Item	Initial factory Setting
Setting mode	Carrier frequency setting mode
<Carrier Frequency>	
Carrier frequency value	10 MHz
Frequency step value	1 MHz
Resolution position	0.01 Hz position
Relative frequency mode	OFF
Frequency offset value	0 Hz
<Output Level>	
Output level value	-30 dBm
Level step value	1 dB
Resolution position	0.01 dB position
Continuous mode	OFF
Relative level mode	OFF
Level offset value	0 dB
RF ON/OFF	ON
Voltage indication	EMF
Level mode	Hi-speed
Isolation mode	OFF
<FM1 Modulation>	
Modulation	OFF
Frequency deviation	0 Hz
Modulation signal source	Int1
<FM2 Modulation>	
Modulation	OFF
Frequency deviation	0 Hz
Modulation signal source	Int1
<AM Modulation>	
AM modulation	OFF
Modulation factor	0 %
Modulation signal source	Int1

APPENDIX A INITIAL FACTORY SETTINGS

Set Item	Initial factory Setting
<Pulse Modulation>	
Modulation	OFF
Modulation input impedance	50 Ω
<Internal Modulation Signal Source (Int1)>	
Frequency	1 kHz
<Internal Modulation Signal Source (Int2)>	
Frequency	1 kHz
Waveform	Sine wave
<Internal Modulation Signal Source (Int3)>	
Frequency	1 kHz
Waveform	Sine wave
<External Modulation Signal Source (Ext1)>	
Coupling	AC
<External Modulation Signal Source (Ext2)>	
Coupling	AC
<AF Output>	
AF signal source	OFF
AF level	1 V _{p-p}
Resolution position	1 mV
<Frequency Sweep>	
Sweep type	START-STOP
Sweep mode	AUTO
Sweep pattern	LIN Δ F
Start frequency	1 MHz
Stop frequency	100 MHz
Center frequency	50.5 MHz
Span frequency	99 MHz
Number of frequency steps	991
Frequency step size	100 kHz
Marker frequency	1 MHz
Sweep time	5 ms/step

Set Item	Initial factory Setting
<Level Sweep>	
Sweep type	START-STOP
Sweep mode	AUTO
Sweep pattern	ΔL
Start level	-35 dBm
Stop level	-15 dBm
Center level	-25 dBm
Span level	20 dB
Number of level steps	21
Level step size	1 dB
Marker level	-35 dBm
Sweep time	5 ms/step
<Memory Sweep>	
Sweep mode	AUTO
Start address	0
Stop address	999
Marker address	0
Sweep time	1 s/step
<Memory>	
Memory contents	No data
Recallable memory blocks	All blocks
Recall mode	All panel information
<Other Functions>	
Bell	OFF
Alarm	ON
Display	ON (Both 7-seg. & EL)
<GPIB>	
GPIB address	3
GPIB function	Talker/listener

(Blank)

APPENDIX B

FUNCTION-KEY TRANSITION

(Blank)

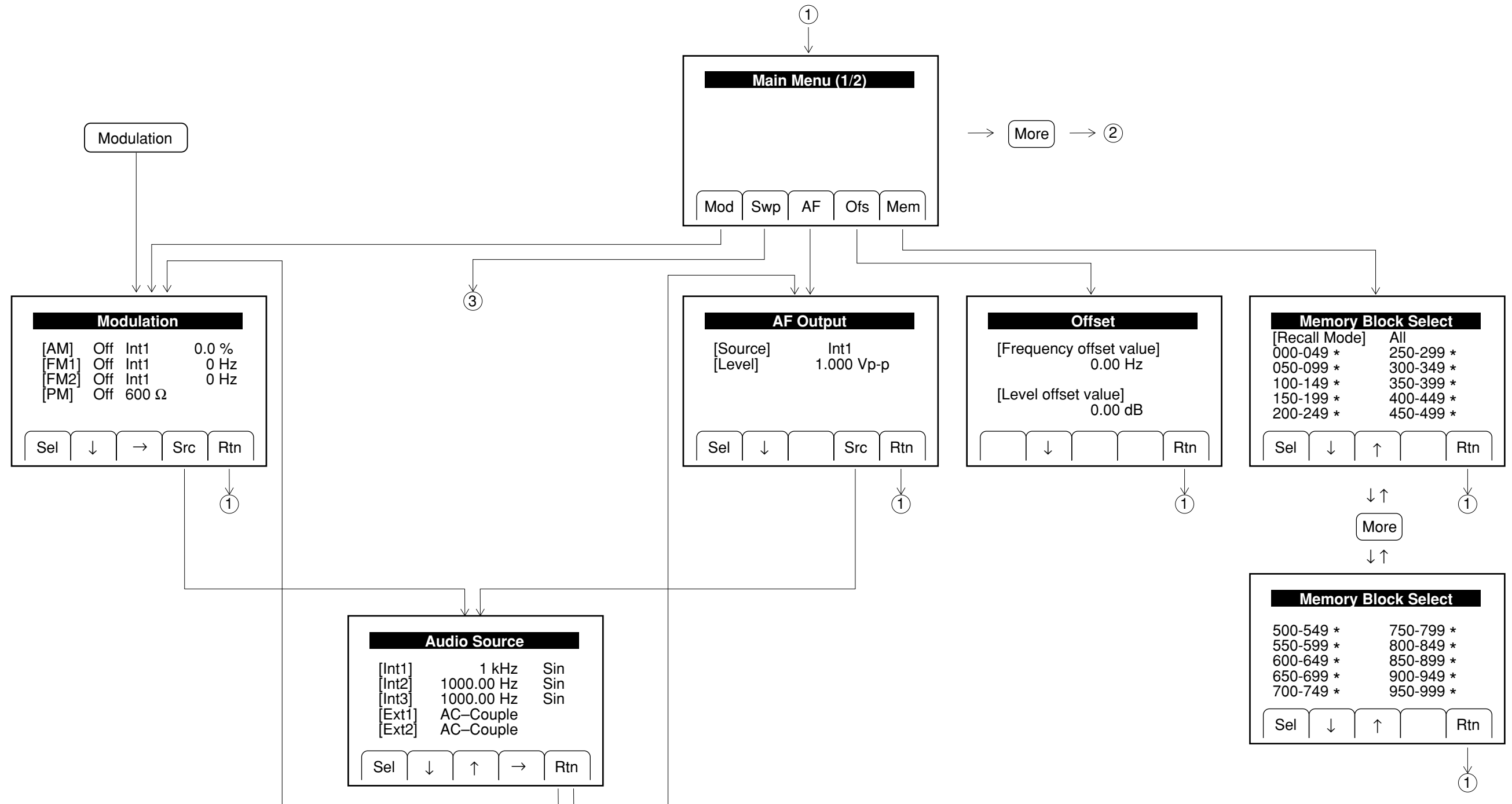

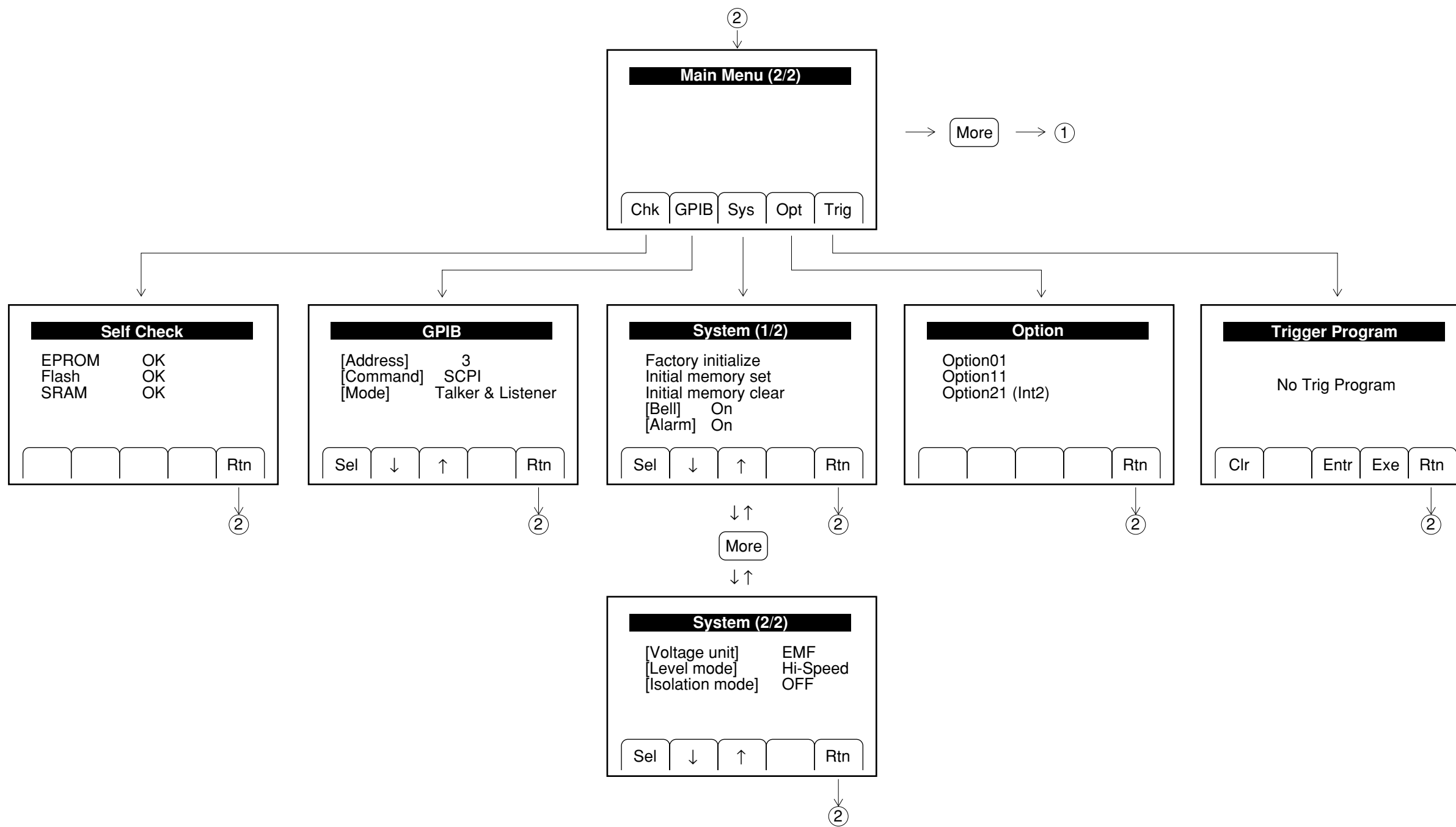

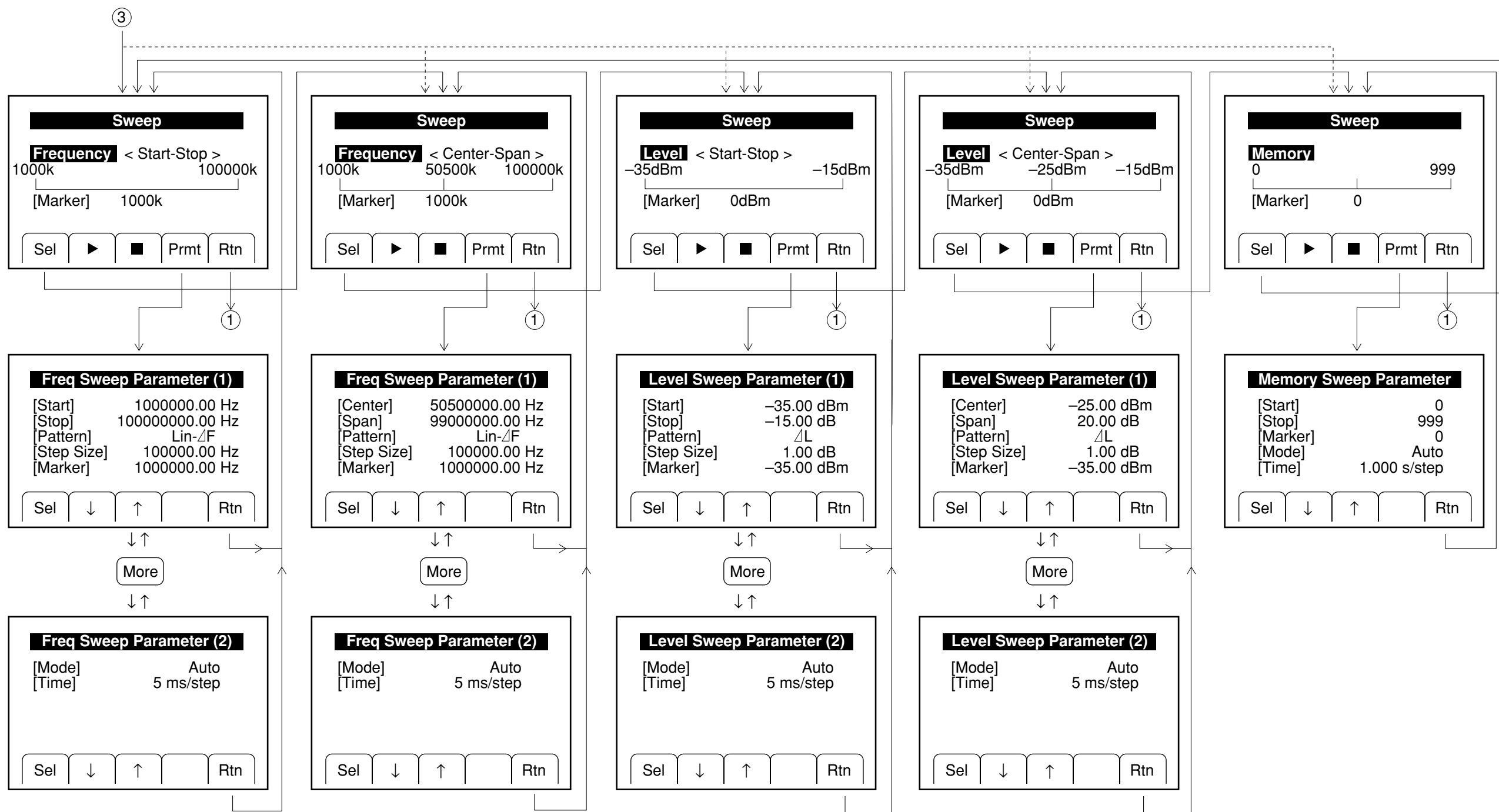

(Blank)

APPENDIX C

FRONT AND REAR PANEL LAYOUT

APPENDIX C FRONT AND REAR PANEL LAYOUT

(Blank)

Anritsu MG3641A Synthesized Signal Generator
125kHz-1040MHz

Modulation

[AM]	On	Int1	30.0 %
[FM1]	Off	Int2	3.500 kHz
[FM2]	Off	Ext1	0.000 kHz
[PM]	Off	50 Ω	

Sel ↓ → Src Rtn

Frequency

1.000000000

GHz MHz kHz Hz

CW Mod Uncal

Memory Output Level

0.000 0.000

dBm V L-Ofs F-Ofs

dB mV EMF

dBμ μV Cont

F1 F2 F3 F4 F5 More

Edit

Frequency Modulation Memory

Resolution Knob Step

Entry

Freq Step Size	Shift	CE	dB Recall
Frequency		BS	GHz/dBm
Level Step Size	7	8	% Store
Level	4	5	MHz/dBμ
Modulation	1	2	sec
Memory Set	0	3	kHz/mV
Memory		-/+	msec Clear
			Hz/μV

Output Level

Rel Freq Cur Dspl Rel Level Cur Dspl

Resolution Knob Step

Stby On

Ext1 Ext2 AF Output

600Ω 2Vp-p 600Ω 2Vp-p 600Ω 0-4Vp-p

RF Off On RPP Reset

RF Output 50Ω Reverse Power 50W Max ±50V DC Max

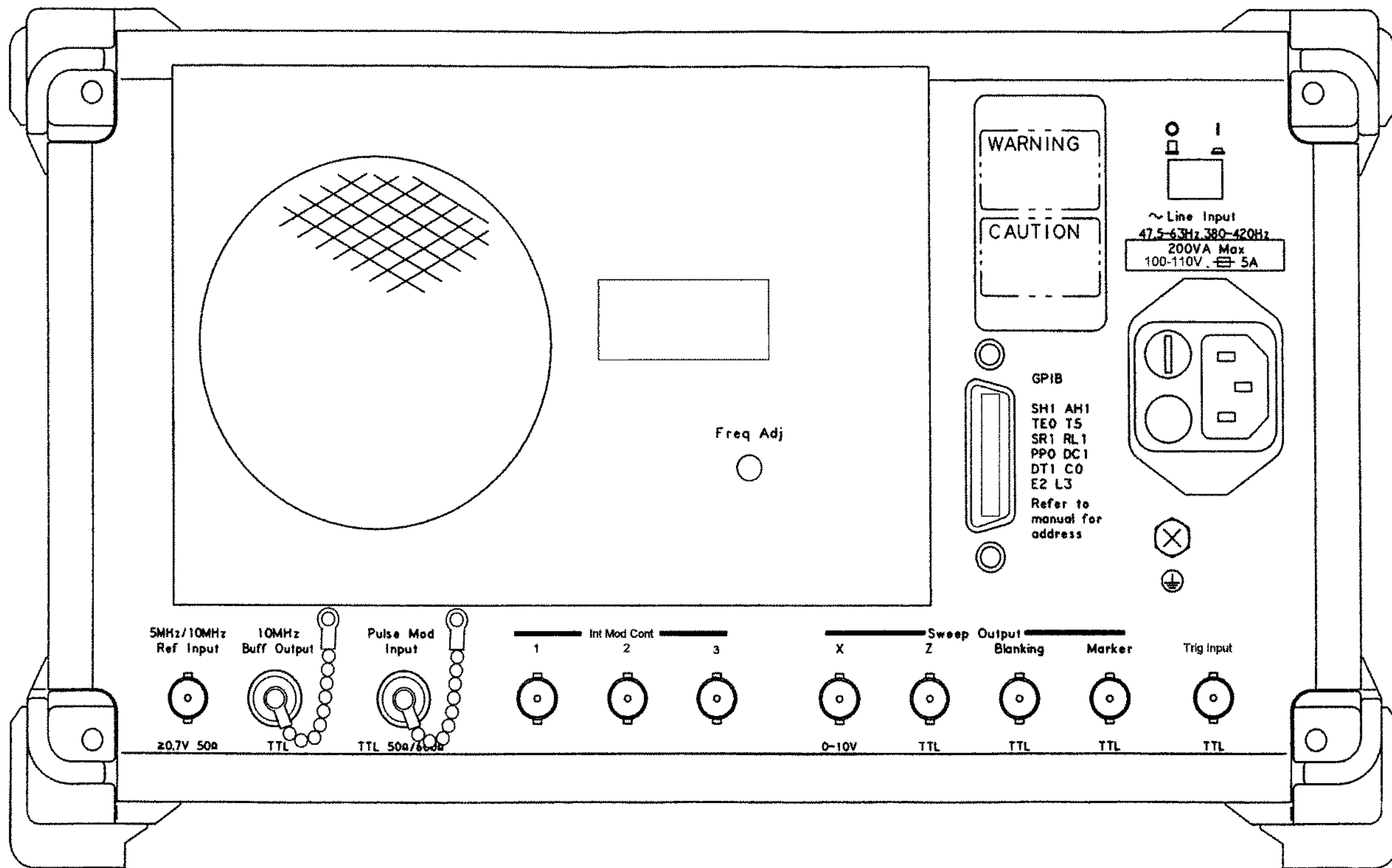

APPENDIX D

INDEX

Note : The number at the right side indicates the paragraph number for the word at the left side.

12 dB SINAD	5.1, 5.1.2
20 dB NQ	5.1, 5.1.1, 5.2.1
A) AC	2.4.2, 3.1.2, 4.1, 4.7.3, 7.3
AC line voltage	2.1.1, 2.2.1, 2.4.2
Address	4.12.3
AF	4.8
AF DDS	4.7.2
AF Output	3.1.1, 4.6.1, 4.8
Alarm	4.12.2
All	4.9.5
AM	4.6.1, 4.6.3, 4.6.5, 4.6.6, 4.7.3
appropriate input level	3.1.1
ASCII	6.2.1
ATE	6.2.2
Attenuator	4.5.4, 4.5.6
Audio Source	4.7.1, 4.7.2, 4.7.3
Auto	4.10.1
B) Bell	4.12.2
Blanking Out	4.10.3
blocking	5.3
Both Talk	4.12.3
C) center frequency	4.10.1
center level	4.10.1
Clear	4.9.4
Clr	4.11.2
command format	6.2.4
command separator	6.2.4
Cont	3.1.1, 4.5.4
cross modulation	5.3
Cur Dspl	4.4.2, 4.4.3, 4.5.2, 4.5.3
CW	3.1.1

APPENDIX D INDEX

D)	DC	4.7.3, 4.13
	digital synthesizer	4.7.2
E)	EMF	3.1.1
	EMI radiation	4.12.1
	Entr	4.11.2
	EOI	6.4.1
	Error message	4.14
	Exe	4.11.1, 4.11.3
	Ext	3.1.1, 4.6.1, 4.6.2, 4.7.3, 4.8
	external modulation	3.1.1, 4.6.1, 4.7.3
F)	Factory initialize	4.3
	FM	4.6.1, 4.6.3, 4.6.4, 4.6.5, 4.7.3
	F-Ofs	3.1.1, 4.4.3
	Freq	4.9.5
	Freq Adj	3.1.2
	Freq & Level	4.9.5
	Freq Step Size	4.4.1
	Freq Talk	4.12.3
	frequency offset	4.4.3
	frequency offset value	4.4.3
	frequency relative value	4.4.2
	Fuse	2.4.1, 2.4.2
G)	GPIB	3.1.2, 4.11.1, 4.11.3, 4.12.3, 6.1.2, 6.1.3, 6.1.4, 6.3
	GPIB command interchange	6.10.1, 6.10.2, 6.10.3
I)	IEEE	6.1.1, 6.1.4, 6.5, 6.5.2
	IFC	6.6.1
	intialization	6.6, 6.6.1, 6.6.2, 6.6.3
	Initial memory clear	4.3
	Initial memory set	4.3
	initial settings	4.3
	input impedance	4.6.6
	Int	4.6.1, 4.6.2, 4.7.1, 4.7.2, 4.8
	inter-modulation	5.3
	internal modulation	4.6.1
K)	Knob Step	4.4.1, 4.5.1

L)	Level Continuous Mode	3.1.1, 4.5.4
	Level mode	4.5.6
	Level offset value	4.5.3
	Level Safety Mode	4.5.6
	Level Step Size	4.5.1
	LF	6.4.1
	Listen Only	4.12.3
	L-Ofs	3.1.1, 4.5.3
	long form	6.2.4
	Lvl Talk	4.12.3
M)	Manual	4.10.1
	Marker Out	4.10.3
	Mem	4.9.3, 4.9.5
	Memory	4.9.2, 4.9.3, 4.9.4
	memory address	3.1.1
	Memory Block Select	4.9.3, 4.9.5
	Memory Set	4.9.2, 4.9.4
	MG3631A/32A	6.10.1, 6.10.3
	MG3633A	6.10.1, 6.10.2
	Mod	3.1.1, 4.6.2
	Mod Cont	3.1.2
	Mod Input	4.7.3
	Modulation	4.6.2, 4.6.3, 4.6.6, 4.7.1, 4.7.2, 4.7.3
	modulation signal source	3.1.1, 4.6.1, 4.6.2
	multi-menu display	3.1.1
N)	NL	6.4.1
	Normal	4.5.4
	NQ	5.1, 5.1.1, 5.2.1
O)	Offset	3.1.1, 4.4.3, 4.5.3
	Ofs	4.4.3, 4.5.3
	Only mode	4.12.3, 6.1.2, 6.1.3
	open-voltage display	4.5.6
	Option	4.6.6, 4.7.2
	output connector	4.5.5
	output level offset	4.5.3
	output level relative value	4.5.2
	output impedance	4.8

APPENDIX D INDEX

P)	PM	4.6.6
	Performance test	7.1, 7.2, 7.3
	polarity of modulation signal	4.6.5
	preset memory	4.3
	Prmt	4.10.2
	Pulse Modulation	3.1.2, 4.6.6
Q)	Query	6.4.1
R)	Recall	4.9.3
	Recall Mode	4.9.5
	receiver	5.1, 5.2
	Rel Freq	4.4.2
	Rel Level	4.5.2
	Reverse Power Protection	4.13
	reverse power protector	2.2.2, 3.1.1
	RPP	4.13
S)	SCPI	4.14, 6.2.2, 6.2.3, 6.10.1
	short form	6.2.4
	SINAD	5.1, 5.1.2
	Single	4.10.1, 4.11.2
	Source	4.8
	span frequency	4.10.1
	span level	4.10.1
	spike noise	4.5.4, 4.5.6
	spurious response	5.2.2
	Src	4.7.1, 4.7.2
	start address	4.10.1
	start frequency	4.10.1
	start level	4.10.1
	status register	6.5.1, 6.5.2, 6.5.3, 6.5.4
	STB	6.5, 6.5.2
	step size	4.10.1
	step address	4.10.1
	step frequency	4.10.1
	stop level	4.10.1
	Store	4.9.2
	subsystem	6.2.3
	Sweep	3.1.2, 4.10.1, 4.10.2

	sweep auxiliary output	4.10.3
	Sweep Parameter	4.10.2, 4.10.3
	Swp	4.10.2
	System	4.3, 4.5.6, 4.12.2
T)	Talker & Listener	4.12.3
	terminated-voltage display	4.5.6
	thermal protector	2.1.1
	transmitter	2.2.2
	Tree	6.2.3, 6.2.4
	Trig	3.1.2, 4.11.1, 4.11.2, 4.11.3
	Trigger Program	4.11.1, 4.11.2, 4.11.3, 4.11.4
U)	Uncal	3.1.1, 4.6.4
	undesired radiation	3.1.1
	Unit type	6.2.7
V)	Voltage unit	4.5.6
X)	X Out	4.10.3
Z)	Z Out	4.10.3

(Blank)

APPENDIX E

PERFORMANCE TEST RESULTS SHEET

This section shows examples of the performance test results sheets for the performance test of the MG3641A/MG3642A. Copy these sheets to record the test result.

APPENDIX E PERFORMANCE TEST RESULTS SHEET

Test site: _____

Report No. _____
 Date _____
 Tested by _____

Model name MG364_A Synthesized Signal Generator

Mfg. No. _____

Ambient temp. _____ °C

AC power freq. _____ Hz

Relative humidity _____ %

Note:

Output frequency (Para. 7.3.1)

Setting	Result
130 kHz	_____
1 MHz	_____
10 MHz	_____
100 MHz	_____
200 MHz	_____
300 MHz	_____
500 MHz	_____
1000 MHz	_____
1500 MHz	_____
2000 MHz	_____

Output level frequency response (Para.7.3.2)

Setting		Min. spec.	Result	Max. spec.
Freq.	Output level			
130 kHz	0 dBm	-0.5 dBm	_____	+0.5 dBm
1 MHz		-0.5 dBm	_____	+0.5 dBm
10 MHz		-0.5 dBm	_____	+0.5 dBm
100 MHz		-0.5 dBm	_____	+0.5 dBm
200 MHz		-0.5 dBm	_____	+0.5 dBm
300 MHz		-0.5 dBm	_____	+0.5 dBm
500 MHz		-0.5 dBm	_____	+0.5 dBm
1000 MHz		-0.5 dBm	_____	+0.5 dBm
1500 MHz		-0.5 dBm	_____	+0.5 dBm
2000 MHz		-0.5 dBm	_____	+0.5 dBm

Output level accuracy (Para.7.3.3)

Set Output level	Min. spec.	Result					Max. Spec.
		10 MHz	100 MHz	500 MHz	1000 MHz	2000 MHz	
+17 dBm	-1 dB	_____	_____	_____	_____	_____	+1 dB
+13 dBm	-1 dB	_____	_____	_____	_____	_____	+1 dB
+7 dBm	-1 dB	_____	_____	_____	_____	_____	+1 dB
+6 dBm	-1 dB	_____	_____	_____	_____	_____	+1 dB
+5 dBm	-1 dB	_____	_____	_____	_____	_____	+1 dB
+4 dBm	-1 dB	_____	_____	_____	_____	_____	+1 dB
+3 dBm	-1 dB	_____	_____	_____	_____	_____	+1 dB
+2 dBm	-1 dB	_____	_____	_____	_____	_____	+1 dB
+1 dBm	-1 dB	_____	_____	_____	_____	_____	+1 dB
0 dBm		Ref.	Ref.	Ref.	Ref.	Ref.	
-1 dBm	-1 dB	_____	_____	_____	_____	_____	+1 dB
-2 dBm	-1 dB	_____	_____	_____	_____	_____	+1 dB
-3 dBm	-1 dB	_____	_____	_____	_____	_____	+1 dB
-8 dBm	-1 dB	_____	_____	_____	_____	_____	+1 dB
-13 dBm	-1 dB	_____	_____	_____	_____	_____	+1 dB
-18 dBm	-1 dB	_____	_____	_____	_____	_____	+1 dB
-23 dBm	-1 dB	_____	_____	_____	_____	_____	+1 dB
-28 dBm	-1 dB	_____	_____	_____	_____	_____	+1 dB
-33 dBm	-1 dB	_____	_____	_____	_____	_____	+1 dB
-38 dBm	-1 dB	_____	_____	_____	_____	_____	+1 dB
-43 dBm	-1 dB	_____	_____	_____	_____	_____	+1 dB
-48 dBm	-1 dB	_____	_____	_____	_____	_____	+1 dB
-53 dBm	-1 dB	_____	_____	_____	_____	_____	+1 dB
-58 dBm	-1 dB	_____	_____	_____	_____	_____	+1 dB
-63 dBm	-1 dB	_____	_____	_____	_____	_____	+1 dB
-68 dBm	-1 dB	_____	_____	_____	_____	_____	+1 dB
-73 dBm	-1 dB	_____	_____	_____	_____	_____	+1 dB
-78 dBm	-1 dB	_____	_____	_____	_____	_____	+1 dB
-83 dBm	-1 dB	_____	_____	_____	_____	_____	+1 dB
-88 dBm	-1 dB	_____	_____	_____	_____	_____	+1 dB
-93 dBm	-1 dB	_____	_____	_____	_____	_____	+1 dB
-98 dBm	-1 dB	_____	_____	_____	_____	_____	+1 dB
-103 dBm	-1 dB	_____	_____	_____	_____	_____	+1 dB
-108 dBm	-1 dB	_____	_____	_____	_____	_____	+1 dB
-113 dBm	-1 dB	_____	_____	_____	_____	_____	+1 dB
-118 dBm	-1 dB	_____	_____	_____	_____	_____	+1 dB
-123 dBm	-1 dB	_____	_____	_____	_____	_____	+1 dB
-128 dBm	-3 dB	_____	_____	_____	_____	_____	+3 dB
-133 dBm	-3 dB	_____	_____	_____	_____	_____	+3 dB
-138 dBm	-3 dB	_____	_____	_____	_____	_____	+3 dB
-143 dBm	-3 dB	_____	_____	_____	_____	_____	+3 dB

APPENDIX E PERFORMANCE TEST RESULTS SHEET

FM deviation accuracy (Para. 7.3.4)

Setting		Min. Spec.	Result	Max. Spec.
Freq.	FM dev.			
10 MHz	300 Hz	275 Hz	_____	325 Hz
	1 kHz	940 Hz	_____	1.06 kHz
	3 kHz	2.84 kHz	_____	3.16 kHz
	10 kHz	9.49 kHz	_____	10.51 kHz
100 MHz	300 Hz	275 Hz	_____	325 Hz
	1 kHz	940 Hz	_____	1.06 kHz
	3 kHz	2.84 kHz	_____	3.16 kHz
	10 kHz	9.49 kHz	_____	10.51 kHz
	30 kHz	28.49 kHz	_____	31.51 kHz
	100 kHz	94.99 kHz	_____	105.01 kHz
500 MHz	300 Hz	275 Hz	_____	325 Hz
	1 kHz	940 Hz	_____	1.06 kHz
	3 kHz	2.84 kHz	_____	3.16 kHz
	10 kHz	9.49 kHz	_____	10.51 kHz
	30 kHz	28.49 kHz	_____	31.51 kHz
	100 kHz	94.99 kHz	_____	105.01 kHz
	300 kHz	284.99 kHz	_____	315.01 kHz
	1000 MHz	300 Hz	265 Hz	_____
1 kHz		930 Hz	_____	1.07 kHz
3 kHz		2.83 kHz	_____	3.17 kHz
10 kHz		9.48 kHz	_____	10.52 kHz
30 kHz		28.48 kHz	_____	31.52 kHz
100 kHz		94.98 kHz	_____	105.02 kHz
300 kHz		284.98 kHz	_____	315.02 kHz
2000 MHz	300 Hz	245 Hz	_____	355 Hz
	1 kHz	910 Hz	_____	1.09 kHz
	3 kHz	2.81 kHz	_____	3.19 kHz
	10 kHz	9.46 kHz	_____	10.54 kHz
	30 kHz	28.46 kHz	_____	31.54 kHz
	100 kHz	94.96 kHz	_____	105.04 kHz
	300 kHz	284.96 kHz	_____	315.04 kHz

FM distortion (Para. 7.3.4)

Set FM dev.	Result					Max. spec.
	10 MHz	100 MHz	500 MHz	1000 MHz	2000 MHz	
3.5 kHz	—	—	—	—	—	-40 dB
22.5 kHz	—	—	—	—	—	-45 dB

AM mod. factor accuracy (Para. 7.3.5)

Set AM dep.	Min. spec.	Result					Max. spec.
		10 MHz	100 MHz	500 MHz	1000 MHz	2000 MHz	
10 %	7.5 %	—	—	—	—	—	12.5 %
30 %	26.5 %	—	—	—	—	—	33.5 %
50 %	45.5 %	—	—	—	—	—	54.5 %
80 %	74.0 %	—	—	—	—	—	86.0 %
90 %	83.5 %	—	—	—	—	—	96.5 %

AM distortion (Para. 7.3.5)

Set AM dep.	Result					Max. spec.
	10 MHz	100 MHz	500 MHz	1000 MHz	2000 MHz	
30 %	—	—	—	—	—	-40 dB
90 %	—	—	—	—	—	-30 dB

APPENDIX E PERFORMANCE TEST RESULTS SHEET

This sheet is used for the calculation at measurement of output level accuracy (para. 7.3.3).

Copy this at the measurement.

Calculation sheet for output level accuracy (Measurement frequency: MHz)

STEP	MG3641A /MG3642A Level setting	Pre-amp.	MS2602A setting			Marker level measured (dBm)	Output level accuracy (dB)	
			Ref. level	RF att.	Average			
STEP4	+17 dBm	OFF	+22 dBm	45 dB	OFF	$Ma_{+17} =$	$Ma_{+17} - Ma_0 - 17 =$	
STEP5	+16 dBm		+21 dBm			$Ma_{+16} =$	$Ma_{+16} - Ma_0 - 16 =$	
STEP6	+15 dBm		+20 dBm			$Ma_{+15} =$	$Ma_{+15} - Ma_0 - 15 =$	
	+14 dBm		+19 dBm			$Ma_{+14} =$	$Ma_{+14} - Ma_0 - 14 =$	
	+13 dBm		+18 dBm			$Ma_{+13} =$	$Ma_{+13} - Ma_0 - 13 =$	
	+12 dBm		+17 dBm			$Ma_{+12} =$	$Ma_{+12} - Ma_0 - 12 =$	
	+11 dBm		+16 dBm			$Ma_{+11} =$	$Ma_{+11} - Ma_0 - 11 =$	
	+10 dBm		+15 dBm			$Ma_{+10} =$	$Ma_{+10} - Ma_0 - 10 =$	
	+9 dBm		+14 dBm			$Ma_{+9} =$	$Ma_{+9} - Ma_0 - 9 =$	
	+8 dBm		+13 dBm			$Ma_{+8} =$	$Ma_{+8} - Ma_0 - 8 =$	
	+7 dBm		+12 dBm			$Ma_{+7} =$	$Ma_{+7} - Ma_0 - 7 =$	
	+6 dBm		+11 dBm			$Ma_{+6} =$	$Ma_{+6} - Ma_0 - 6 =$	
	+5 dBm		+10 dBm			$Ma_{+5} =$	$Ma_{+5} - Ma_0 - 5 =$	
	+4 dBm		+9 dBm			$Ma_{+4} =$	$Ma_{+4} - Ma_0 - 4 =$	
	+3 dBm		+8 dBm			$Ma_{+3} =$	$Ma_{+3} - Ma_0 - 3 =$	
	+2 dBm		+7 dBm			$Ma_{+2} =$	$Ma_{+2} - Ma_0 - 2 =$	
	+1 dBm		+6 dBm			$Ma_{+1} =$	$Ma_{+1} - Ma_0 - 1 =$	
	0 dBm		+5 dBm			$Ma_0 =$	$Ma_0 - Ma_0 - 0 =$	
-1 dBm	+4 dBm		$Ma_{-1} =$			$Ma_{-1} - Ma_0 + 1 =$		
-2 dBm	+3 dBm		$Ma_{-2} =$			$Ma_{-2} - Ma_0 + 2 =$		
-3 dBm	+2 dBm	$Ma_{-3} =$	$Ma_{-3} - Ma_0 + 3 =$					
-8 dBm	-3 dBm	$Ma_{-8} =$	$Ma_{-8} - Ma_0 + 8 =$					
STEP8	-8 dBm	OFF	-3 dBm	25 dB	OFF	$Mb_{-8} =$	$(K_{-8} = Mb_{-8} - Ma_{-8} =)$	
STEP9	-13 dBm		-8 dBm			$Mb_{-13} =$	$Mb_{-13} - Ma_0 - K_{-1} + 13 =$	
	-18 dBm		-13 dBm			$Mb_{-18} =$	$Mb_{-18} - Ma_0 - K_{-1} + 18 =$	
	-23 dBm		-18 dBm			$Mb_{-23} =$	$Mb_{-23} - Ma_0 - K_{-1} + 23 =$	
STEP11	-28 dBm	OFF	-23 dBm	5 dB	OFF	$Mb_{-28} =$	$Mb_{-28} - Ma_0 - K_{-1} + 28 =$	
	STEP12		-33 dBm			-28 dBm	$Mc_{-33} =$	$(K_2 = Mc_{-33} - Mb_{-28} + K_{-1} =)$
-38 dBm			-33 dBm			$Mc_{-38} =$	$Mc_{-38} - Ma_0 - K_2 + 38 =$	
-43 dBm			-38 dBm			$Mc_{-43} =$	$Mc_{-43} - Ma_0 - K_2 + 43 =$	
STEP14	-48 dBm	ON	-43 dBm	25 dB	OFF	$Mc_{-48} =$	$Mc_{-48} - Ma_0 - K_2 + 48 =$	
	STEP15		-48 dBm			-3 dBm	$Md_{-48} =$	$(K_3 = Md_{-48} - Mc_{-48} + K_2 =)$
-53 dBm			-8 dBm			$Md_{-53} =$	$Md_{-53} - Mc_0 - K_3 + 53 =$	
-58 dBm			-13 dBm			$Md_{-58} =$	$Md_{-58} - Ma_0 - K_3 + 58 =$	
STEP17	-63 dBm	ON	-18 dBm	5 dB	OFF	$Md_{-63} =$	$Md_{-63} - Ma_0 - K_3 + 63 =$	
	-68 dBm		-23 dBm			$Md_{-68} =$	$Md_{-68} - Ma_0 - K_3 + 68 =$	
	STEP18		-68 dBm			-23 dBm	$Me_{-68} =$	$(K_4 = Me_{-68} - Md_{-68} + K_3 =)$
			-73 dBm			-28 dBm	$Me_{-73} =$	$Me_{-73} - Ma_0 - K_4 + 73 =$
-78 dBm			-33 dBm			$Me_{-78} =$	$Me_{-78} - Ma_0 - K_4 + 78 =$	
-83 dBm			-38 dBm			$Me_{-83} =$	$Me_{-83} - Ma_0 - K_4 + 83 =$	
-88 dBm			-43 dBm			$Me_{-88} =$	$Me_{-88} - Ma_0 - K_4 + 88 =$	
-93 dBm			-48 dBm			$Me_{-93} =$	$Me_{-93} - Ma_0 - K_4 + 93 =$	
-98 dBm			-53 dBm			$Me_{-98} =$	$Me_{-98} - Ma_0 - K_4 + 98 =$	
-103 dBm			-58 dBm			$Me_{-103} =$	$Me_{-103} - Ma_0 - K_4 + 103 =$	
-108 dBm			-63 dBm			$Me_{-108} =$	$Me_{-108} - Ma_0 - K_4 + 108 =$	
-113 dBm			-68 dBm			$Me_{-113} =$	$Me_{-113} - Ma_0 - K_4 + 113 =$	
-118 dBm			-73 dBm			$Me_{-118} =$	$Me_{-118} - Ma_0 - K_4 + 118 =$	
-123 dBm			-73 dBm			$Me_{-123} =$	$Me_{-123} - Ma_0 - K_4 + 123 =$	
-128 dBm	-73 dBm		$Me_{-128} =$			$Me_{-128} - Ma_0 - K_4 + 128 =$		
-133 dBm	-73 dBm		$Me_{-133} =$			$Me_{-133} - Ma_0 - K_4 + 133 =$		
-138 dBm	-73 dBm	$Me_{-138} =$	$Me_{-138} - Ma_0 - K_4 + 138 =$					
-143 dBm	-73 dBm	$Me_{-143} =$	$Me_{-143} - Ma_0 - K_4 + 143 =$					